



STAGE PIANO

CP88

CP73

Owner's Manual

SPECIAL MESSAGE SECTION

PRODUCT SAFETY MARKINGS: Yamaha electronic products may have either labels similar to the graphics shown below or molded/stamped facsimiles of these graphics on the enclosure. The explanation of these graphics appears on this page. Please observe all cautions indicated on this page and those indicated in the safety instruction section.

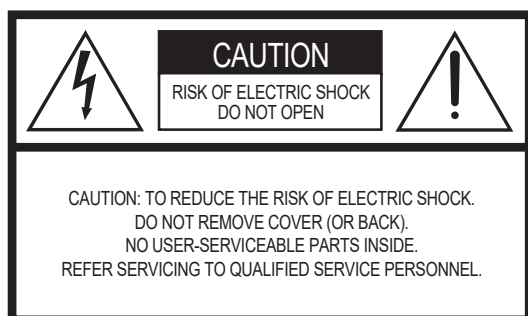

The exclamation point within the equilateral triangle is intended to alert the user to the presence of important operating and maintenance (servicing) instructions in the literature accompanying the product.

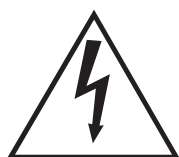

The lightning flash with arrowhead symbol, within the equilateral triangle, is intended to alert the user to the presence of uninsulated “dangerous voltage” within the product’s enclosure that may be of sufficient magnitude to constitute a risk of electrical shock.

IMPORTANT NOTICE: All Yamaha electronic products are tested and approved by an independent safety testing laboratory in order that you may be sure that when it is properly installed and used in its normal and customary manner, all foreseeable risks have been eliminated. DO NOT modify this unit or commission others to do so unless specifically authorized by Yamaha. Product performance and/or safety standards may be diminished. Claims filed under the expressed warranty may be denied if the unit is/has been modified. Implied warranties may also be affected.

SPECIFICATIONS SUBJECT TO CHANGE: The information contained in this manual is believed to be correct at the time of printing. However, Yamaha reserves the right to change or modify any of the specifications without notice or obligation to update existing units.

ENVIRONMENTAL ISSUES: Yamaha strives to produce products that are both user safe and environmentally friendly. We sincerely believe that our products and the production methods used to produce them, meet these goals. In keeping with both the letter and the spirit of the law, we want you to be aware of the following:

Battery Notice: This product MAY contain a small non-rechargeable battery which (if applicable) is soldered in place. The average life span of this type of battery is approximately five years. When replacement becomes necessary, contact a qualified service representative to perform the replacement.

Warning: Do not attempt to recharge, disassemble, or incinerate this type of battery. Keep all batteries away from children. Dispose of used batteries promptly and as regulated by applicable laws. Note: In some areas, the servicer is required by law to return the defective parts. However, you do have the option of having the servicer dispose of these parts for you.

Disposal Notice: Should this product become damaged beyond repair, or for some reason its useful life is considered to be at an end, please observe all local, state, and federal regulations that relate to the disposal of products that contain lead, batteries, plastics, etc.

NOTICE: Service charges incurred due to lack of knowledge relating to how a function or effect works (when the unit is operating as designed) are not covered by the manufacturer’s warranty, and are therefore the owners responsibility. Please study this manual carefully and consult your dealer before requesting service.

NAME PLATE LOCATION: The graphic below indicates the location of the name plate. The model number, serial number, power requirements, etc., are located on this plate. You should record the model number, serial number, and the date of purchase in the spaces provided below and retain this manual as a permanent record of your purchase.

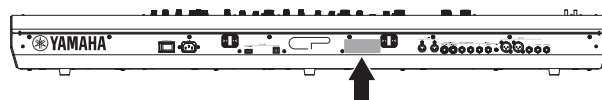

Model _____

Serial No. _____

Purchase Date _____

FCC INFORMATION (U.S.A.)

1. IMPORTANT NOTICE: DO NOT MODIFY THIS UNIT!

This product, when installed as indicated in the instructions contained in this manual, meets FCC requirements. Modifications not expressly approved by Yamaha may void your authority, granted by the FCC, to use the product.

2. IMPORTANT:

When connecting this product to accessories and/or another product use only high quality shielded cables. Cable/s supplied with this product MUST be used. Follow all installation instructions. Failure to follow instructions could void your FCC authorization to use this product in the USA.

3. NOTE:

This product has been tested and found to comply with the requirements listed in FCC Regulations, Part 15 for Class "B" digital devices. Compliance with these requirements provides a reasonable level of assurance that your use of this product in a residential environment will not result in harmful interference with other electronic devices. This equipment generates/uses radio frequencies and, if not installed and used according to the instructions found in the users manual, may cause interference harmful to the operation of other electronic devices. Compliance with FCC regula-

tions does not guarantee that interference will not occur in all installations. If this product is found to be the source of interference, which can be determined by turning the unit "OFF" and "ON", please try to eliminate the problem by using one of the following measures:

Relocate either this product or the device that is being affected by the interference.

Utilize power outlets that are on different branch (circuit breaker or fuse) circuits or install AC line filter/s.

In the case of radio or TV interference, relocate/reorient the antenna. If the antenna lead-in is 300 ohm ribbon lead, change the lead-in to co-axial type cable.

If these corrective measures do not produce satisfactory results, please contact the local retailer authorized to distribute this type of product. If you can not locate the appropriate retailer, please contact Yamaha Corporation of America, Electronic Service Division, 6600 Orangethorpe Ave, Buena Park, CA90620

The above statements apply ONLY to those products distributed by Yamaha Corporation of America or its subsidiaries.

* This applies only to products distributed by YAMAHA CORPORATION OF AMERICA.

(class B)

COMPLIANCE INFORMATION STATEMENT (DECLARATION OF CONFORMITY PROCEDURE)

Responsible Party: Yamaha Corporation of America
Address: 6600 Orangethorpe Ave., Buena Park, Calif. 90620
Telephone: 714-522-9011
Type of Equipment: STAGE PIANO
Model Name: CP88, CP73

This device complies with Part 15 of the FCC Rules.

Operation is subject to the following two conditions:

1) this device may not cause harmful interference, and

2) this device must accept any interference received including interference that may cause undesired operation.

See user manual instructions if interference to radio reception is suspected.

* This applies only to products distributed by YAMAHA CORPORATION OF AMERICA.

(FCC DoC)

Information for users on collection and disposal of old equipment:



This symbol on the products, packaging, and/or accompanying documents means that used electrical and electronic products should not be mixed with general household waste.

For proper treatment, recovery and recycling of old products, please take them to applicable collection points, in accordance with your national legislation.

By disposing of these products correctly, you will help to save valuable resources and prevent any potential negative effects on human health and the environment which could otherwise arise from inappropriate waste handling.

For more information about collection and recycling of old products, please contact your local municipality, your waste disposal service or the point of sale where you purchased the items.

For business users in the European Union:

If you wish to discard electrical and electronic equipment, please contact your dealer or supplier for further information.

Information on Disposal in other Countries outside the European Union:

This symbol is only valid in the European Union. If you wish to discard these items, please contact your local authorities or dealer and ask for the correct method of disposal.

(weee_eu_en_02)

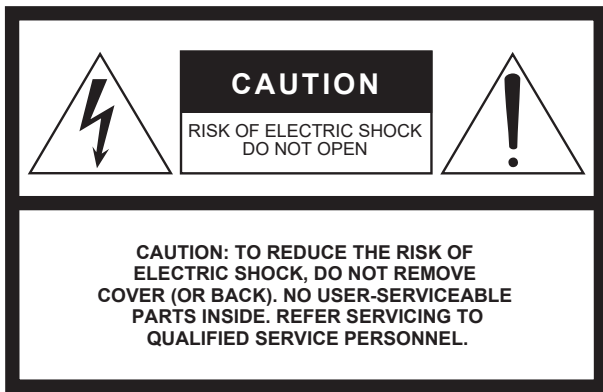

The above warning is located on the rear of the unit.

Explanation of Graphical Symbols



The lightning flash with arrowhead symbol within an equilateral triangle is intended to alert the user to the presence of uninsulated “dangerous voltage” within the product’s enclosure that may be of sufficient magnitude to constitute a risk of electric shock to persons.



The exclamation point within an equilateral triangle is intended to alert the user to the presence of important operating and maintenance (servicing) instructions in the literature accompanying the product.

IMPORTANT SAFETY INSTRUCTIONS

- 1 Read these instructions.
- 2 Keep these instructions.
- 3 Heed all warnings.
- 4 Follow all instructions.
- 5 Do not use this apparatus near water.
- 6 Clean only with dry cloth.
- 7 Do not block any ventilation openings. Install in accordance with the manufacturer’s instructions.
- 8 Do not install near any heat sources such as radiators, heat registers, stoves, or other apparatus (including amplifiers) that produce heat.
- 9 Do not defeat the safety purpose of the polarized or grounding-type plug. A polarized plug has two blades with one wider than the other. A grounding type plug has two blades and a third grounding prong. The wide blade or the third prong are provided for your safety. If the provided plug does not fit into your outlet, consult an electrician for replacement of the obsolete outlet.
- 10 Protect the power cord from being walked on or pinched particularly at plugs, convenience receptacles, and the point where they exit from the apparatus.
- 11 Only use attachments/accessories specified by the manufacturer.
- 12 Use only with the cart, stand, tripod, bracket, or table specified by the manufacturer, or sold with the apparatus. When a cart is used, use caution when moving the cart/apparatus combination to avoid injury from tip-over.
- 13 Unplug this apparatus during lightning storms or when unused for long periods of time.
- 14 Refer all servicing to qualified service personnel. Servicing is required when the apparatus has been damaged in any way, such as power-supply cord or plug is damaged, liquid has been spilled or objects have fallen into the apparatus, the apparatus has been exposed to rain or moisture, does not operate normally, or has been dropped.



WARNING

TO REDUCE THE RISK OF FIRE OR ELECTRIC SHOCK, DO NOT EXPOSE THIS APPARATUS TO RAIN OR MOISTURE.

(UL60065_03)

PRECAUTIONS

PLEASE READ CAREFULLY BEFORE PROCEEDING

Please keep this manual in a safe and handy place for future reference.



WARNING

Always follow the basic precautions listed below to avoid the possibility of serious injury or even death from electrical shock, short-circuiting, damages, fire or other hazards. These precautions include, but are not limited to, the following:

Power supply/Power cord

- Do not place the power cord near heat sources such as heaters or radiators. Also, do not excessively bend or otherwise damage the cord, or place heavy objects on it.
- Only use the voltage specified as correct for the instrument. The required voltage is printed on the name plate of the instrument.
- Use only the supplied power cord/plug.
- Check the electric plug periodically and remove any dirt or dust which may have accumulated on it.
- Be sure to connect to an appropriate outlet with a protective grounding connection. Improper grounding can result in electrical shock.

Do not open

- This instrument contains no user-serviceable parts. Do not open the instrument or attempt to disassemble or modify the internal components in any way. If it should appear to be malfunctioning, discontinue use immediately and have it inspected by qualified Yamaha service personnel.

Water warning

- Do not expose the instrument to rain, use it near water or in damp or wet conditions, or place on it any containers (such as vases, bottles or glasses) containing liquids which might spill into any openings. If any liquid such as water seeps into the instrument, turn off the power immediately and unplug the power cord from the AC outlet. Then have the instrument inspected by qualified Yamaha service personnel.
- Never insert or remove an electric plug with wet hands.

Fire warning

- Do not put burning items, such as candles, on the unit. A burning item may fall over and cause a fire.

If you notice any abnormality

- When one of the following problems occur, immediately turn off the power switch and disconnect the electric plug from the outlet. Then have the device inspected by Yamaha service personnel.
 - The power cord or plug becomes frayed or damaged.
 - It emits unusual smells or smoke.
 - Some object has been dropped into the instrument.
 - There is a sudden loss of sound during use of the instrument.



CAUTION

Always follow the basic precautions listed below to avoid the possibility of physical injury to you or others, or damage to the instrument or other property. These precautions include, but are not limited to, the following:

Power supply/Power cord

- Do not connect the instrument to an electrical outlet using a multiple-connector. Doing so can result in lower sound quality, or possibly cause overheating in the outlet.
- When removing the electric plug from the instrument or an outlet, always hold the plug itself and not the cord. Pulling by the cord can damage it.
- Remove the electric plug from the outlet when the instrument is not to be used for extended periods of time, or during electrical storms.

Location

- Do not place the instrument in an unstable position where it might accidentally fall over.
- Before moving the instrument, remove all connected cables, to prevent damage to the cables or injury to anyone who might trip over them.
- When setting up the product, make sure that the AC outlet you are using is easily accessible. If some trouble or malfunction occurs, immediately turn off the power switch and disconnect the plug from the outlet. Even when the power switch is turned off, electricity is still flowing to the product at the minimum level. When you are not using the product for a long time, make sure to unplug the power cord from the wall AC outlet.

Connections

- Before connecting the instrument to other electronic components, turn off the power for all components. Before turning the power on or off for all components, set all volume levels to minimum.
- Be sure to set the volumes of all components at their minimum levels and gradually raise the volume controls while playing the instrument to set the desired listening level.

Handling caution

- Do not insert a finger or hand in any gaps on the instrument.
- Never insert or drop paper, metallic, or other objects into the gaps on the panel. This could cause physical injury to you or others, damage to the instrument or other property, or operational failure.
- Do not rest your weight on, or place heavy objects on the instrument, and do not use excessive force on the buttons, switches or connectors.
- Do not use the instrument/device or headphones for a long period of time at a high or uncomfortable volume level, since this can cause permanent hearing loss. If you experience any hearing loss or ringing in the ears, consult a physician.

Yamaha cannot be held responsible for damage caused by improper use or modifications to the instrument, or data that is lost or destroyed.

Always turn the power off when the instrument is not in use.

Even when the [⏻] (Standby/On) switch is in standby status (display is off), electricity is still flowing to the instrument at the minimum level.

When you are not using the instrument for a long time, make sure you unplug the power cord from the wall AC outlet.

NOTICE

To avoid the possibility of malfunction/ damage to the product, damage to data, or damage to other property, follow the notices below.

■ Handling

- Do not use the instrument in the vicinity of a TV, radio, stereo equipment, mobile phone, or other electric devices. Otherwise, the instrument, TV, or radio may generate noise. When you use the instrument along with an application on your iPad, iPhone or iPod touch, we recommend that you set “Airplane Mode” to “ON” on that device in order to avoid noise caused by communication.
- Do not expose the instrument to excessive dust or vibrations, or extreme cold or heat (such as in direct sunlight, near a heater, or in a car during the day) to prevent the possibility of panel disfiguration, damage to the internal components or unstable operation.
- Do not place vinyl, plastic or rubber objects on the instrument, since this might discolor the panel or keyboard.

■ Maintenance

- When cleaning the instrument, use a soft and dry/ slightly damp cloth. If the panel (front, side and bottom, excepting the controllers and the keyboard) is dirty, wipe the dirt away using a cloth moistened with a neutral detergent solution and tightly wrung out. Following this, wipe away the detergent solution using a cloth soaked in water and tightly wrung out. Do not use paint thinners, solvents, alcohol, or chemical-impregnated wiping cloths.
- During extreme changes in temperature or humidity, condensation may occur and water may collect on the surface of the instrument. If water is left, the wooden parts may absorb the water and be damaged. Make sure to wipe any water off immediately with a soft cloth.

■ Saving data

- Edited Live set sound and settings of MENU/ SETTINGS screens are lost when you turn off the power to the instrument. This also occurs when the power is turned off by the Auto Power Off function (page 21). Save the data to the instrument, or to USB flash drive/an external device such as a computer (page 23). However, the data saved to the instrument may be lost due to some failure, an operation mistake, etc. Save your important data onto USB flash drive/an external device such as a computer (page 23). Before using a USB flash drive, make sure to refer to page 24.
- To protect against data loss through USB flash drive damage, we recommend that you save your important data onto spare USB flash drive or an external device such as a computer as backup data.

Information

■ About copyrights

- Copying of the commercially available musical data including but not limited to MIDI data and/or audio data is strictly prohibited except for your personal use.
- This product incorporates and bundles contents in which Yamaha owns copyrights or with respect to which Yamaha has license to use others' copyrights. Due to copyright laws and other relevant laws, you are NOT allowed to distribute media in which these contents are saved or recorded and remain virtually the same or very similar to those in the product.
 - * The contents described above include a computer program, Accompaniment Style data, MIDI data, WAVE data, voice recording data, a score, score data, etc.
 - * You are allowed to distribute medium in which your performance or music production using these contents is recorded, and the permission of Yamaha Corporation is not required in such cases.

■ About this manual

- The illustrations and LCD screens as shown in this manual are for instructional purposes only, and may appear somewhat different from those on your instrument.
- iPhone, iPad, Logic Pro are trademarks of Apple Inc., registered in the U.S. and other countries.
- IOS is a trademark or registered trademark of Cisco in the U.S. and other countries and is used under license.
- Cubase is a registered trademark of Steinberg Media Technologies GmbH.
- Ableton Live is a trademarks of Ableton AG.
- Pro Tools® is a registered trademark of Avid Technology, Inc.
- The company names and product names in this manual are the trademarks or registered trademarks of their respective companies.

The model number, serial number, power requirements, etc., may be found on or near the name plate, which is at the rear of the unit. You should note this serial number in the space provided below and retain this manual as a permanent record of your purchase to aid identification in the event of theft.

Model No.

Serial No.

(rear_en_01)

Welcome

Thank you for purchasing the Yamaha CP88 or CP73.

This instrument is a Stage Piano designed especially for live performance.

Please read this Owner's Manual carefully before using the instrument in order to take full advantage of its various features. When you have finished reading the manual, keep it in a safe, accessible place, and refer to it when you need to better understand an operation or function.

Accessories

- Owner's Manual (this book)
- Power cord
- Foot pedal (FC3A)

Main Features

■ Authentic acoustic- and electric-piano sounds of unparalleled quality

Building on our decades of experience in the production of stage pianos, we have meticulously adjusted the sound of each individual key and realized perfect balance over the full length of the keyboard, creating full-bodied piano tones ideal for solo performances and authentically rich sounds well suited for playing within an ensemble. Furthermore, by analyzing and replicating the sound-producing mechanisms of classic electric pianos using cutting-edge technologies, we have been able to achieve an extremely smooth response in the CP88 and CP73 keyboards.

■ Weighted hammer-action keyboards

CP series employ a keyboard with a weighted hammer-action design that is virtually indistinguishable from an acoustic piano. The CP88's NW-GH3 (Natural Wood Graded Hammer keyboard with synthetic ebony and ivory keytops) keyboard reproduce a touch of grand piano by giving all keys an authentic resistance that increases from the top register to the lower. And the CP73 features a BHS (Balanced Hammer Standard) keyboard with matte black keytops, perfect for performing as an electric piano as well.

■ Design embodies high-class appearance and portability

Featuring a stylish, finely crafted aluminum exterior in a light, compact package, the CP88 and CP73 project an exceptionally professional appearance and provide convenient portability onstage.

■ User interface provides direct, intuitive control required for live performance

The three Voice sections—Piano, E.Piano and Sub—are indicated clearly on the top panel, giving you all the controllers you need onstage, allowing you to directly adjust each parameter as you need while you play. The LED indicator lamps show you the selected Voice, letting you fully concentrate on your performance. Moreover, you can enhance sounds on-the-fly, adding various effects to suit your performance as you play.

■ Connect with other devices and expand your performance potential

Comprehensive MIDI controls and powerful Master Keyboard features make it easy to connect and use the instrument with software synthesizers and external MIDI devices. Moreover, the instrument has a built-in USB Audio/MIDI interface for convenient recording functions in home and professional studios, as well as onstage performance power.

Contents

PRECAUTIONS	5
NOTICE	7
Information	7
Welcome	8
Accessories	8
Main Features	8

Controls and Functions **10**

Front Panel	10
Settings of LCD and the indicator lamp	10
Live Set	12
Storing a Live Set Sound	12
Swapping Live Set Sounds	13
Copying a Live Set Sound	13
Piano section	14
Copying a section	14
Electric Piano section	15
Sub section	16
Delay section/Reverb section	16
Master EQ	17
Rear Panel	18

Setting Up **20**

Power Supply	20
Connecting Speakers or Headphones	20
Turning On and Off	20
Auto Power Off Function	21
Restoring the Factory Default Settings (Factory Reset)	21

Basic Structure & Display Content **21**

Selecting Voices	21
Exiting from the Current Screen	21
Display Configuration	21
Editing File Names/Live Set Sound Names	22

Saving / Loading Data **23**

Saving the settings to a USB flash drive	23
Loading the settings from a USB flash drive	23

Using with Other MIDI Devices **25**

Controlling a synthesizer or tone generator module from this instrument	25
Controlling this instrument from an external MIDI keyboard or synthesizer	25

Using with a Computer **26**

Connecting to a computer	26
Connecting an iPhone or iPad	27

MENU LIST **28**

SETTINGS LIST **33**

DATA LIST **37**

Live Set Sound List	37
Voice List	39
Control Change Number List	40
MIDI	43
MIDI Data Format	44
MIDI Data Table	46
MIDI Implementation Chart	50

Appendix **51**

Display Messages	51
Troubleshooting	52
Specifications	54
Index	55

Controls and Functions

Front Panel

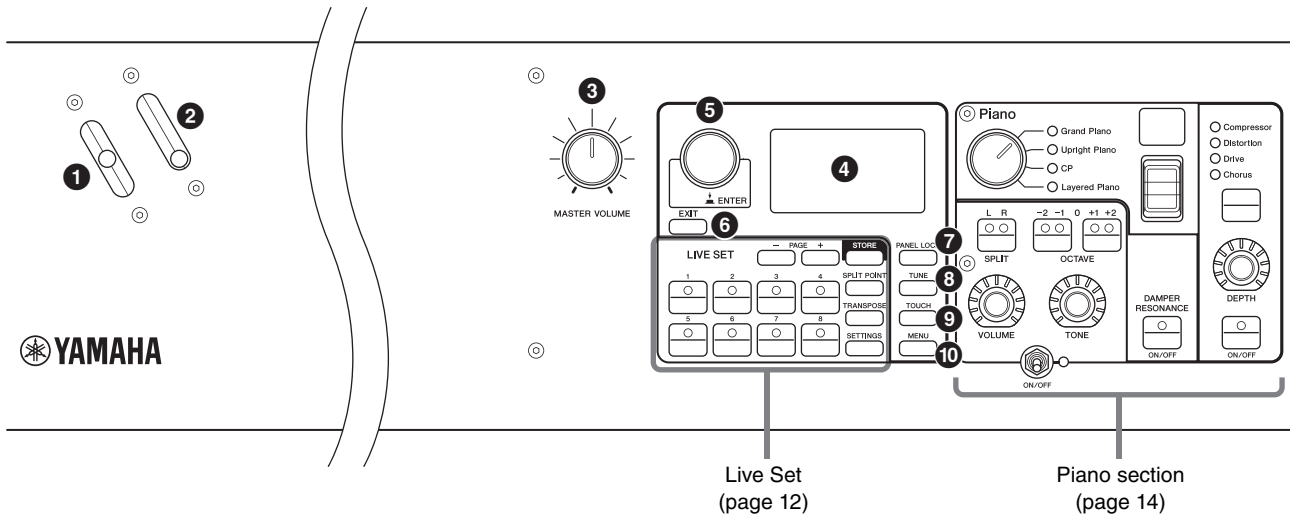

Live Set
(page 12)

Piano section
(page 14)

1 Pitch bend lever

Use this controller to smoothly raise or lower the pitch of played notes. When you release it, the lever will automatically spring back to the original position, and the pitch will return to normal.

The range can be set for each section from the [SETTINGS] button → “Controllers” → “Bend Range” (page 36).

2 Modulation lever

Use this lever to apply vibrato to the sound. The vibrato depth can be set for each section from the [SETTINGS] button → “Controllers” → “P.Mod Depth” (page 36).

When the “Rotary” insertion effect of the Sub section is selected, this lever functions as a controller to switch the rotary speed (Fast, Slow).

3 [MASTER VOLUME] knob

Use this knob to adjust the overall volume of the instrument.

4 LCD

Displays the system messages, parameter settings, and a range of other information depending on the function currently being used.

■ Settings of LCD and the indicator lamp

To make the following settings, press the [MENU] button → “Control Panel” → “Display Lights.”

Section	For setting “Off” to light the lamps of each section that is linked with the Voice section [ON/OFF] switches, or “On” so that they continuously light.
Ins Effect	For setting “Off” to light each insertion effect lamps linked with the Insertion effect [ON/OFF] buttons, or “On” to continuously light the lamps.
LCD SW	Set this to “On” to light the Top screen, or “Off” to turn off. However, regardless of this setting, the various setting screens such as the MENU screens and the SETTINGS screens are always lit.
LCD Contrast	For adjusting the contrast of the LCD.

5 Encoder dial/[ENTER] button

Use this dial to display the Live Set view and to edit the currently selected parameter. In the MENU screens and the SETTINGS screens, move the cursor (highlighted) up or down to select an event for editing. Also, pressing this dial is equivalent to pressing the [ENTER] button. Use this button to determine the selected parameter or to execute each operation.

6 [EXIT] button

The MENU screens and the SETTINGS screens are organized according to a hierarchical structure. Press this button to exit from the current screen and return to the previous level in the hierarchy.

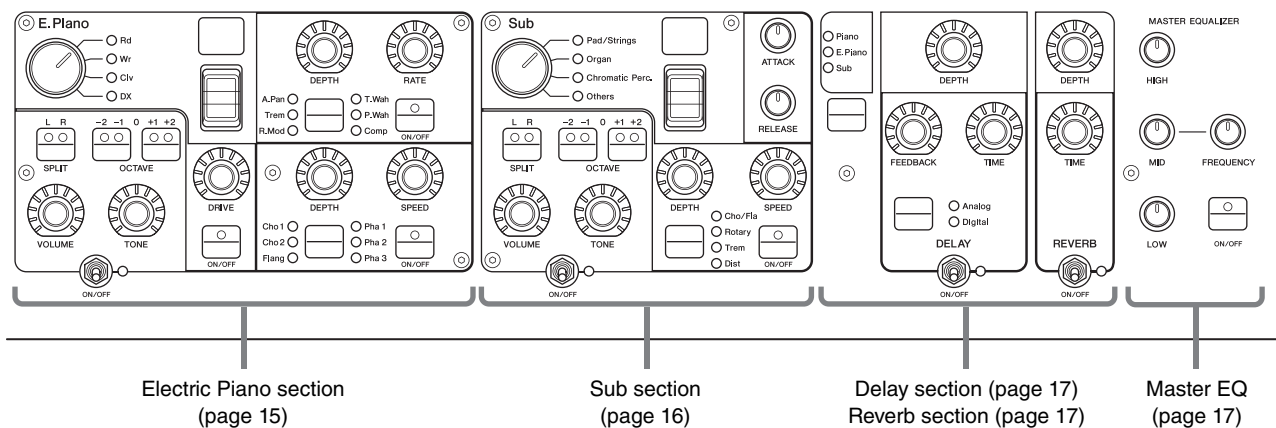

7 [PANEL LOCK] button

Use this button to switch the panel lock function on and off. When this is set to “On,” control panel operations are disabled, ensuring that settings cannot be inadvertently changed. Pressing the button alternates between lock and unlock. While the panel lock is engaged, will appear on the top left corner of the LCD display.

NOTE

Panel lock settings can be made individually for the following areas from the [MENU] button → “Control Panel” → “Panel Lock Settings.”

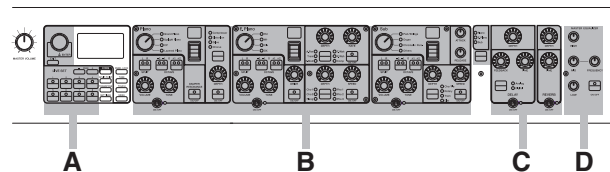

- A. Live Set
- B. Piano/E.Piano/Sub
- C. Delay/Reverb
- D. Master EQ

8 [TUNE] button

Use this button to set the tuning for the entire instrument (414.72 – 466.78 Hz). Press the [TUNE] button, and then use the Encoder dial to change the value.

NOTE

The default value is 440.00 Hz.

9 [TOUCH] button

Displays the screen to select a curve for determining how the actual velocities will be generated according to the strength with which you play notes on the keyboard. The available settings are as follows. The setting also can be changed from the [MENU] button → “General” → “Keyboard/Pedal” → “Touch Curve” (page 29).

Settings	Characteristics
Normal	This curve produces velocities in direct proportion to the strength of your keyboard playing. This is the most common type of curve.
Soft	This curve makes it easier to produce high velocities across the entire keyboard.
Hard	This curve makes it more difficult to produce high velocities across the entire keyboard.
Wide	This curve accentuates your playing strength by producing lower velocities in response to softer playing and louder velocities in response to harder playing. You can use this setting to expand the dynamic range of your performances.
Fixed	This curve produces the same amount of sound change, regardless of how hard or soft you play the keyboard. The fixed velocity can be set from the [MENU] button → “General” → “Keyboard/Pedal” → “Fixed Velocity.”

10 [MENU] button

Use this button to call up the screens for making overall system settings.

Live Set

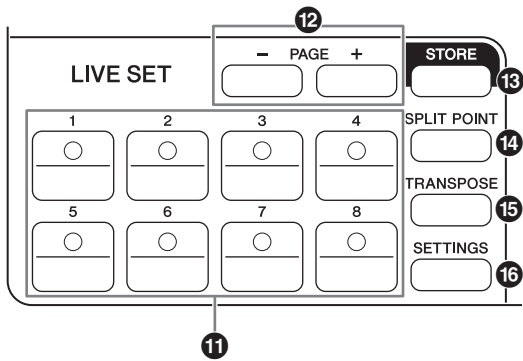

11 Live Set Sound [1] – [8] button

Use these buttons to call up the stored Live Set Sounds.

Live Set Sound

This is a combination of Voices/effects, consisting of the sounds of all Voice sections – Piano section (page 14), Electric Piano section (page 15), and Sub section (page 16) and effects of the Delay section (page 17) and the Reverb section (page 17). You can combine sounds and insertion effects, to create and store a custom Live Set Sound.

The Live Set feature supports SSS (Seamless Sound Switching), ensuring that the sound does not cut off even when changed, resulting in smoother transitions between Live Set Sounds and a more natural performance.

NOTE

If you wish to mute the sound continued by the effect of SSS, press again the currently selected Live Set Sound button.

12 PAGE [-]/[+] buttons

Use these buttons to switch the Live Set Pages. The Live Set Sound switches accordingly.

Live Set

Combines the Live Set Sounds [1] – [8] into one page. With the default settings (factory settings), the preset Live Set Sounds are installed in from page 1 to page 10.

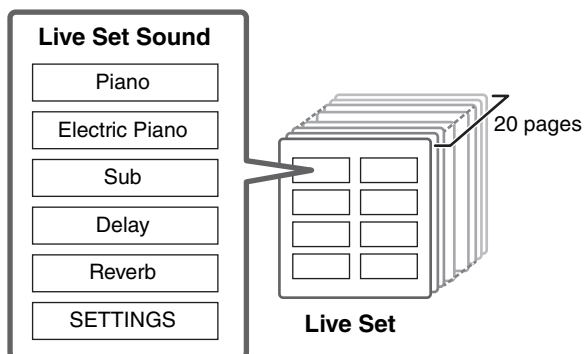

Live Set View

Displays a Live Set Page (Live Set Sound [1] – [8]) in a single screen, for convenient overall view of the available sounds. To open the Live Set View, turn the Encoder dial when at the Top screen. The will appear on the left of the currently selected Live Set Sound. To change the Live Set Sound in Live Set View, turn the Encoder dial to select a Live Set Sound, and press the [ENTER] button to return to the Top screen. To have the Live Set view shown on the Top screen, change the settings of “Live Set View Mode” to “Keep” (page 31).

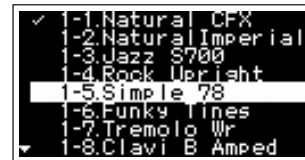

Live Set View Mode

13 [STORE] button

Use this button to store the edited Live Set Sound. Settings of the sections listed below and their parameters can be stored. Stored settings will be retained when this instrument is turned off.

- Piano section
- Electric Piano section
- Sub section
- Delay section
- Reverb section
- SETTINGS (includes Split Point and Transpose)

NOTE

The Master EQ settings cannot be stored in Live Set Sound.

■ Storing a Live Set Sound

1. Press the [STORE] button.

Select a Live Set Sound you wish to store the currently edited Live Set Sound setting into.



2. Press the [ENTER] button to execute.

A “Completed.” message will appear on the screen, and then return to the Top screen.

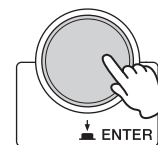

NOTE

If you wish to store the currently edited settings to another Live Set Sound, use the Encoder dial to select the Live Set Sound which is to be the store destination. Press the keyboard to confirm that the sound has been changed to the edited settings.

**NOTICE**

- Keep in mind that the settings will be overwritten when you select an existing Live Set Sound (including one of the preset Live Set Sounds). Proceed with caution.
- The settings currently be edited will be lost if you select another Live Set Sound before storing, or turn off the power.

NOTE

- Edits made to a Live Set Sound are normally lost if not stored before selecting a different Live Set Sound; however, by using the “Edit Recall” function, you can recall the last edited condition (page 32).
- You can download the preset Live Set Sounds from Soundmondo. Soundmondo is an iOS application for storing and managing Voice data.
- Please refer to the following Yamaha web page for more details on Soundmondo.
<http://www.yamaha.com/kbdapps/>

■ Swapping Live Set Sounds**1. Select the Live Set Sound you wish to swap.****2. Call up the Swap screen.**

[MENU] button → “Job” → “Live Set Manager” → “Swap.”

**3. Select a Live Set Sound.**

Use the Encoder dial to select a Live Set Sound to swap, and then press the [ENTER] button. The messages “Executing.” → “Completed.” will appear on the screen, and then return to the Top screen.

■ Copying a Live Set Sound**1. Select the Live Set Sound you wish to copy.****2. Call up the Copy screen.**

[MENU] button → “Job” → “Live Set Manager” → “Copy.”

**3. Select the desired Live Set Sound location.**

Use the Encoder dial to select the Live Set Sound intended for the store destination, and then press the [ENTER] button. The messages “Executing.” → “Completed.” will appear on the screen, and then return to the Top screen.

14 [SPLIT POINT] button

Use this button to change the Split Point. Turn the Encoder dial or press the key you wish to assign as the Split Point. The setting will be stored in Live Set Sound.

Split

This function allows you to play different Voices with the left and right hands. The point on the keyboard that separates the left hand section and the right hand section of the keyboard is called the “Split Point.”

NOTE

- The default setting is “G2”
- The lowest note of the right hand section is referred as the Split Point.
- The Split Point can be changed from the [SETTINGS] button → “Function” → “Split Point” (page 33).

15 [TRANPOSE] button

Use this button to adjust the pitch of the keyboard up or down in semitone steps. The settings can be stored to the Live Set Sound. The settings can be changed from the [SETTINGS] button → “Function” → “Sound Transpose” (page 33).

16 [SETTINGS] button

Use this button to call up the SETTINGS screens. In the SETTINGS screens, you can make detailed settings for the current selected Live Set Sound (page 33), which will then be stored for the Live Set Sound.

Piano section

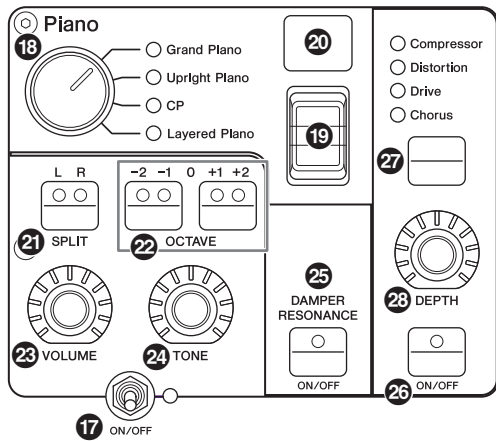

17 Voice section [ON/OFF] switch

Use these switches to determine whether the corresponding Voice section is enabled (ON) or not (OFF). When these indicator lamps are lit, the corresponding Voice sound is produced when you play the keyboard.

■ Copying a section

The settings of each Voice section can be copied with the following operation.

1. Select the Voice section you wish to copy.

Select the Live Set Sound which contains the Voice section you wish to copy. Press the [MENU] button → “Job” → “Section Manager” → “Copy,” then select the Voice section you wish to copy.

A “Section copied.” message will appear on the screen, and then return to the Top screen.

2. Select a Voice section you wish to paste.

Select the Live Set Sound which contains the Voice section you wish to paste the copied section. Press the [MENU] button → “Job” → “Section Manager” → “Paste,” then select the Voice section you wish to paste.

A “Section pasted.” message will appear on the screen, and then return to the Top screen.

18 Voice category selector

The Voices in each Voice section are divided into four categories. To select a Voice, select a Voice category first.

Voice section	Voice category
Piano	Grand Piano, Upright Piano, CP, Layered Piano
Electric Piano	Rd, Wr, Clv, DX
Sub	Pad/Strings, Organ, Chromatic Perc., Others

19 Voice select switch

Use this switch to select one of the Voices of the category selected with the Voice category selector. For information about the Voices, refer to page 39.

20 Voice number display

Displays the currently selected Voice numbers.

21 SPLIT [L R] button

Press these buttons to alternate between the keyboard-split settings of each Voice section. The area for which the indicator lamp is lit will sound.

NOTE

The Split Point can be changed from the [SPLIT POINT] button (page 13), also from the [SETTINGS] → “Function” → “Split Point” (page 33).

22 OCTAVE [-2 -1]/[+1 +2] buttons

Use these buttons to change the octave range of the keyboard. To restore the normal octave setting, press both buttons simultaneously.

23 [VOLUME] knob

Use these knobs to adjust the volume of each Voice section.

24 [TONE] knob

Use these knobs to adjust the tone of each Voice section. Setting the knob to the center position produces a flat, evenly balanced sound. Turn the knob to the right (clockwise) to boost the higher and lower ranges. Turn the knob to the left (counter-clockwise) to cut the higher range and the lower range.

25 DAMPER RESONANCE [ON/OFF] button

Use this button to switch the damper resonance effect on and off. This simulates the rich sound of open strings produced when the damper pedal of a piano is pressed.

26 Insertion effect [ON/OFF] button

Use this button to apply the insertion effects.

NOTE

To more easily confirm the setting value when the display light is turned off, you can turn the light on from the [MENU] button → “Control Panel” → “Display Lights” → “Ins Effect” (page 30).

27 Insertion effect switch button

Use this button to switch among the following effects. The indicator lamp of the selected effect is lit.

Effect	Description
Compressor	Stereo compressor. To increase the compressor effect, turn the [DEPTH] knob to the right (clockwise).

Effect	Description
Distortion	Monaural compressor plus distortion. Settings from the left-most to the center of the [DEPTH] knob applies compression. Turning the [DEPTH] knob from the center to right (clockwise) increases the amount of distortion.
Drive	Drive effect. Turning the [DEPTH] knob to the right (clockwise) increases the amount of distortion, with the maximum value producing an AM radio-like tone.
Chorus	Stereo chorus. Turning the [DEPTH] knob to the right (clockwise) increases the amount of chorus effect.

28 [DEPTH] knob

Use this knob to adjust the depth of the selected effect.

Electric Piano section

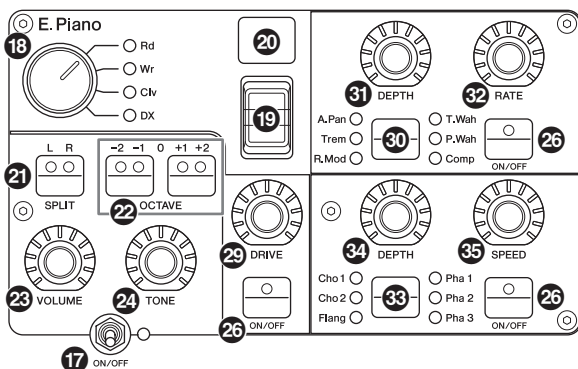

29 [DRIVE] knob

Use this knob to adjust the amount of the drive effect. Simulates the distortion produced by a tube amp.

30 Insertion effect switch button

Use this button to switch among the following effects. The indicator lamp of the selected effect is lit.

Effect	Description
A.Pan	Auto pan built into vintage electric pianos. Turn the [DEPTH] knob to adjust the effect depth, and turn the [RATE] knob to adjust the effect speed.
Trem	Tremolo built into vintage electric pianos. Turn the [DEPTH] knob to adjust the effect depth, and turn the [RATE] knob to adjust the effect speed.
R.Mod	Ring modulator. Turn the [DEPTH] knob to adjust the effect depth, and turn the [RATE] knob to adjust the frequency. Depending on the settings of the [RATE] knob, this effect also can be used as tremolo.

Effect	Description
T.Wah	Wah responds to keyboard dynamics. Turn the [DEPTH] knob to adjust the effect strength, and turn the [RATE] knob to adjust the effect amount.
P.Wah	Wah synchronized to an expression pedal connected to the FOOT CONTROLLER [2] jack. Turn the [DEPTH] knob to adjust the amount of distortion, and turn the [RATE] knob to adjust the amount of resonance.
Comp	Stereo compressor. Turn the [DEPTH] knob to adjust the effect depth, and turn the [RATE] knob to adjust the sound volume.

31 [DEPTH] knob

Use this knob to adjust the depth of the selected effect.

32 [RATE] knob

Use this knob to adjust the modulation speed of the selected effect.

33 Insertion effect switch button

Use this button to switch among the following effects. The indicator lamp of the selected effect is lit.

Effect	Description
Cho 1	Traditional Yamaha multiple chorus. Turn the [DEPTH] knob to adjust the effect depth, and turn the [SPEED] knob to adjust the speed.
Cho 2	Simulates a thick detune chorus produced by the vintage TX816 tone generator. Turn the [DEPTH] knob to adjust the effect depth, and turn the [SPEED] knob to adjust the speed.
Flang	Stereo flanger. Turn the [DEPTH] knob to adjust the feedback amount, and turn the [SPEED] knob to adjust the speed.
Pha 1	Phaser applies a smooth and unique sweeping effect. The sweeping effect can be changed by turning the [DEPTH] knob to left/right. Turn the [SPEED] knob to adjust the speed.
Pha 2	Standard phaser. Turn the [DEPTH] knob to adjust the effect strength. Turn the [SPEED] knob to adjust the speed.
Pha 3	Features two different phaser systems. Turn the [DEPTH] knob to switch the depth of "Pha 1" and "Pha 2." Turn the [SPEED] knob to adjust the speed.

34 [DEPTH] knob

Use this knob to adjust the depth of the selected effect.

35 [SPEED] knob

Use this knob to adjust the modulation speed of the selected effect.

Sub section

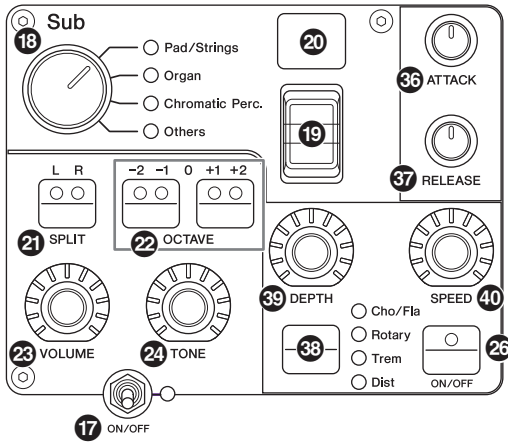

36 [ATTACK] knob

Use this knob to adjust the attack time.

37 [RELEASE] knob

Use this knob to adjust the release time.

NOTE

After you change a Live Set Sound, turning the [ATTACK] knob or the [RELEASE] knob does not actually affect the sound until their position reaches the set values of the currently selected Live Set Sound. Until then, the value will be shown in parentheses.

38 Insertion effect switch button

Use this button to switch among the following effects. The indicator lamp of the selected effect is lit.

Effect	Description
Cho/Fla	Chorus/Flanger. Turn the [DEPTH] knob to adjust the effect depth. Turn the [SPEED] knob to adjust the speed. Settings from the left-most to the center of the [DEPTH] knob apply a chorus effect, while settings from the center to the right (clockwise) apply a flanger effect (similar to the sound of jet).
Rotary	Rotary speaker. Turn the [DEPTH] knob to adjust the balance between rotary speaker and horn speaker. Turn the [SPEED] knob to adjust the rotation speed. Turning the [DEPTH] knob to the left applies the horn speaker, and turning to the right applies the rotary speaker. Turning the [SPEED] knob from the center to left decreases the rotation speed, and turning the knob from the center to right increases the speed. The speed can be changed by using the Modulation lever.
Trem	Standard tremolo. Turn the [DEPTH] knob to adjust the effect depth, and turn the [SPEED] knob to adjust the speed.
Dist	British hard rock type distortion. Turn the [DEPTH] knob to adjust the amount of distortion, and turn the [SPEED] knob to adjust the presence.

39 [DEPTH] knob

Use this knob to adjust the depth of the selected effect.

40 [SPEED] knob

Use this knob to adjust the modulation speed of the selected effect.

Effect

The CP88 and CP73 feature insertion effects and delay/reverb effects that can be configured for each Voice section, as well as a master EQ that affects all the Voice sections in the same way. The illustration below shows the audio signal path.

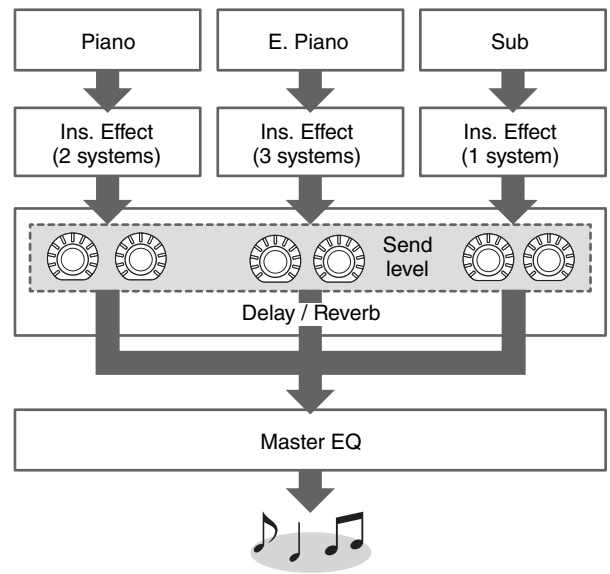

Delay section/Reverb section

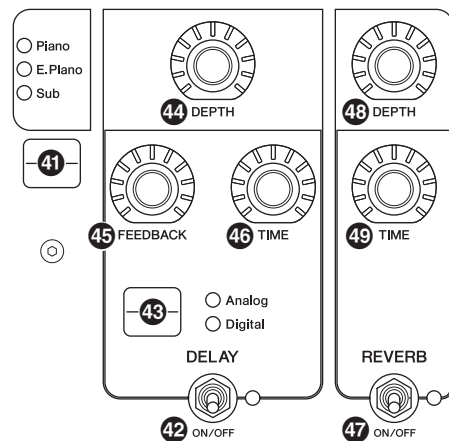

41 Effect level display switch button

Use this button to select the desired Voice sections for adjusting the send levels to delay and reverb effects. Turn the [DEPTH] knobs of the Delay section and the Reverb section to adjust the send levels from each Voice section.

When all the indicator lamps of the Voice sections are lit, the send levels from each Voice section can be adjusted equally. When the send levels of each Voice section are set individually, the indicator lamp of the [DEPTH] knob is unlit. However, when the send levels are readjusted, the indicator lamp of the [DEPTH] knob lights, and the send levels are changed from the previously set value.

■ Delay section

42 DELAY [ON/OFF] switch

Use this switch to determine whether to apply (ON) the delay effect or not (OFF). Delay effects create a delayed version of the input signal, and as such, they can be used for many different purposes, such as creating a sense of spaciousness or thickening a sound.

43 [Analog/Digital] switch button

Use this button to switch between the analog delay and the digital delay. The indicator lamp of the selected effect is lit.

Effect	Description
Analog	Typical warm sound of analog delay. Use the [DEPTH] knob to adjust the effect depth, the [FEEDBACK] knob to adjust the number of repeats, and the [TIME] knob to adjust the delay time. The maximum delay time is 800 ms.
Digital	Clean digital delay. Use the [DEPTH] knob to adjust the effect depth, the [FEEDBACK] knob to adjust the number of repeats, and the [TIME] knob to adjust the delay time. The maximum delay time is 1,486 ms.

44 [DEPTH] knob

Use this knob to adjust the effect depth. Also you can adjust the send level for each Voice section with the Effect level display switch button.

45 [FEEDBACK] knob

Use this knob to adjust the feedback level output from the delay that is returned to the input.

NOTE

The sound will be oscillated when the feedback level is set to high levels. To reduce the oscillation, lower the feedback level, or set the DELAY [ON/OFF] switch to OFF. If the Live Set Sound is changed to another while the sound is still oscillating, the controls of the delay section will not be effective in controlling the oscillation. Press the currently selected Live Set Sound button again to stop the oscillation.

46 [TIME] knob

Use this knob to set the feedback delay time.

■ Reverb section

47 REVERB [ON/OFF] switch

Use this switch to determine whether to apply (ON) the reverb effect or not (OFF). Reverb effects create a rich special ambience of various performance environments, such as a concert hall or a night club.

48 [DEPTH] knob

Use this knob to adjust the depth of the reverb effect. Also use the Effect level display switch button to adjust the effect level individually for each Voice section.

49 [TIME] knob

Use this knob to set the duration of the reverb effect (max. 30 s).

Master EQ

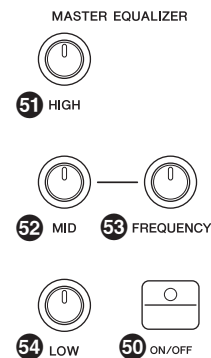

50 MASTER EQUALIZER [ON/OFF] button

Use this button to determine whether to apply (ON) the Master EQ or not (OFF). Master EQ adjusts the overall tone of the sound.

NOTE

The Master EQ settings are a global control and cannot be stored to a Live Set Sound.

51 [HIGH] knob

Use this knob to adjust the gain (-12 to +12) of the high EQ band (5 kHz).

52 [MID] knob

Use this knob to adjust the gain (-12 to +12) of the mid EQ band (100 to 10 kHz).

53 [FREQUENCY] knob

Use this knob to adjust the center frequency of the midrange.

54 [LOW] knob

Use this knob to adjust the gain (-12 to +12) of the low EQ band (80 Hz).

Rear Panel

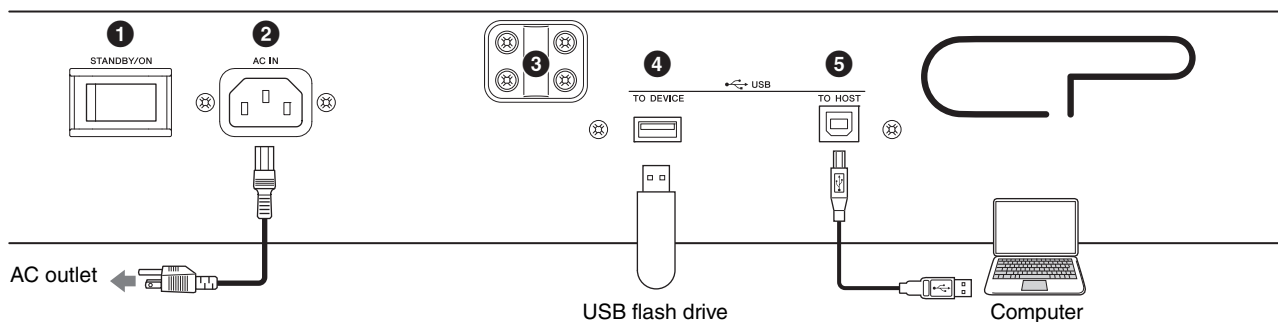

1 [STANDBY/ON] switch

For switching the instrument to standby or turning it on.

2 [AC IN] jack

For connecting the supplied AC power cord.

3 Music stand attachment holes

Use these two holes to attach a music stand (sold separately).

4 USB [TO DEVICE] terminal

Use this terminal to connect a USB flash drive to this instrument, for saving data you have created and loading data you want to restore.

NOTE

Only USB flash drive can be recognized by this instrument. No other USB devices (such as a hard disk drive, CD-ROM drive or USB hub) can be used.

5 USB [TO HOST] terminal

This terminal lets you connect this instrument to a computer, iPhone or iPad via a USB cable, allowing you to transfer MIDI data and audio data between the devices. Unlike MIDI, USB can handle multiple ports via a single cable. For information about how this instrument handles Ports, see page 25.

NOTE

- Audio data sending capability for the instrument is a maximum two channels (one stereo channel) at a sampling rate of 44.1 kHz.
- For details on connecting an iPhone or iPad, refer to page 27.

6 MIDI [IN]/[OUT] terminals

With a standard MIDI cable (available separately), you can connect an external MIDI instrument, and control it from this instrument. Likewise, you can use an external MIDI device (such as a keyboard or sequencer) to control the sounds on this instrument.

7 FOOT SWITCH [SUSTAIN] jack

Use this jack to connect an FC3A Foot Switch (provided) for use as a dedicated sustain pedal.

8 FOOT SWITCH [ASSIGNABLE] jack

Use this jack to connect a separately sold foot switch (FC4A or FC5) in order to perform a range of freely assignable functions such as a soft pedal, sostenuto pedal, and switching Live Set Sounds. With the default settings, “Live Set+” is assigned.

You can assign functions from the [MENU] button → “General” → “Keyboard/Pedal” → “Foot Switch Assign” (page 30). Refer to page 40 for a list of the parameters that can be assigned to this instrument.

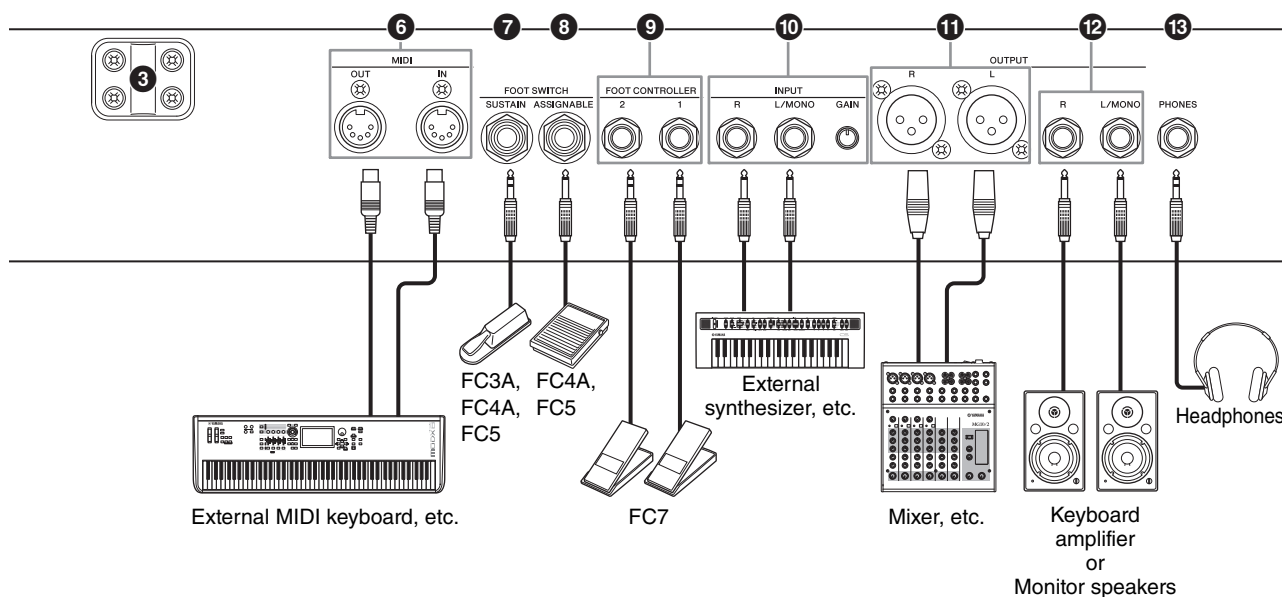

9 FOOT CONTROLLER [1]/[2] jacks

Use these jacks to connect a separately sold foot controller (FC7) in order to continuously control one of various different assignable functions by foot, such as volume and the tone of Voice sections. With the default settings, “Expression” is assigned to the FOOT CONTROLLER [1], and “Pedal Wah” is assigned to the FOOT CONTROLLER [2].

You can assign functions to the foot controller from the [SETTINGS] button → “Controllers” → “FC1 Assign”/ “FC2 Assign.” Refer to page 40 for a list of the parameters that can be assigned.

10 INPUT [L/MONO]/[R] jacks/[GAIN] knob

These jacks allow you to connect an external audio devices and mix the output of that device with that of this instrument. Use the [GAIN] knob to adjust the volume balance with this instrument.

11 OUTPUT [L]/[R] jacks

Use these two XLR-type jacks together to output balanced audio signals.

12 OUTPUT [L/MONO]/[R] jacks

Use these two standard 1/4" mono audio jacks together to output unbalanced stereo signals. When using mono output, connect only to the [L/MONO] jack.

NOTE

- Select either jack 11 or 12 depending on the external audio devices to be connected.
- In case both 11 and 12 jacks are connected to external audio devices, the audio signals will be output from the both jacks simultaneously.

13 [PHONES] jack

Use this standard 1/4" stereo audio jack to connect a pair of headphones.

CAUTION

- To prevent hearing loss, avoid using headphones at high volumes for extended periods of time.
- Whenever connecting other audio equipment, ensure that all devices are turned off.

NOTE

The sound output via the headphones is identical to that output via the OUTPUT [L]/[R] jacks and the OUTPUT [L/MONO]/[R] jacks. Furthermore, plugging in or disconnecting a set of headphones has no effect on the sound being output via these jacks.

Setting Up

Power Supply

Connect the ends supplied AC power cord in the following order. Make sure the [STANDBY/ON] switch on the instrument is set to the STANDBY position.

1. Connect the supplied power cord to the [AC IN] jack on the instrument's rear panel.
2. Connect the other end of the power cord to an AC outlet.

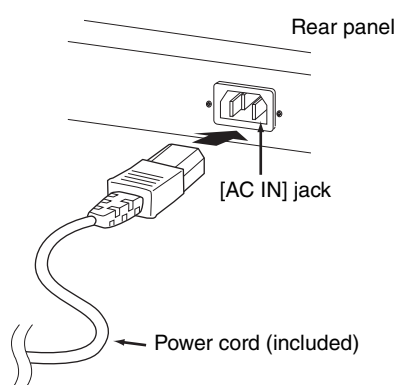

NOTE

Follow this procedure in reverse order when disconnecting the power cord.

WARNING

- Use only the AC power cord supplied with your instrument. The use of an inappropriate replacement can lead to overheating or electric shock.
- The power cord supplied with your instrument must not be used with other electrical equipment. Failure to observe this precaution can result in damage to the equipment or fire.
- Make sure your instrument the voltage requirement for the country or region in which it is being used.

CAUTION

The instrument remains charged and draws a small amount of power even when the [STANDBY/ON] switch is set to the STANDBY position. If you intend not to use it for an extended period of time, therefore, make sure to unplug the power cord from the wall outlet.

Connecting Speakers or Headphones

Since the instrument has no built-in speakers, you will need to monitor the sound of the instrument by using external equipment. Connect a set of headphones, monitor speakers, or other playback equipment as illustrated below. When making connections, be sure that your cables have the appropriate ratings.

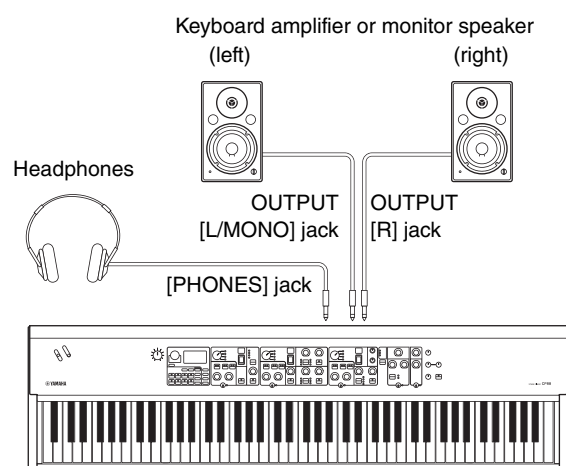

Turning On and Off

Make sure the volume settings of the instrument and external devices such as powered speakers are turned to the minimum before turning the power on. When connecting the instrument to monitor speakers, turn on the power switch of each device in the following order.

■ Turning on

Turn the [MASTER VOLUME] knob of this instrument to its minimum (left-most setting) → set the [STANDBY/ON] switch to ON → turn the amplifier or speaker power on.

■ Turning off

Turn the [MASTER VOLUME] knob of this instrument to its minimum (left-most setting) → turn the amplifier or speaker power off → set the [STANDBY/ON] switch to STANDBY.

Auto Power Off Function

The Auto Power Off function automatically turns off this instrument after 30 minutes of inactivity. By default, this is set to “Disable.”

■ Setting the Auto Power Off function

[MENU] button → “General” → “Auto Power Off” → “Enable” (page 30).

NOTICE

- Since any unsaved data will be lost when the Auto Power Off function turns off this instrument. Make sure to store your work before this occurs.
- Depending on the instrument status, the power may not turn off automatically, even after the specified period of time elapses. Always turn off the power manually when the instrument is not in use.

Restoring the Factory Default Settings (Factory Reset)

The Factory Reset function allows you to restore this instrument to its initial condition. To execute the factory Reset function, press the [MENU] button → “Job” → “Factory Reset.”

NOTICE

When the Factory Reset function is executed, all the Live Set Sounds and the settings of MENU screens and SETTINGS screens will be overwritten with their defaults. It is wise, therefore, to regularly create backup copies of important data on a USB flash drive or the like.

NOTE

Refer to page 37 for information on detailed settings of preset Live Set Sounds.

Basic Structure & Display Content

Selecting Voices

Voices are divided into three Voice sections: Piano, Electric piano and Sub.

Use each Voice section [ON/OFF] switch to enable (ON) or disable (OFF) the corresponding Voice section. When the indicator lamp of the Voice section [ON/OFF] switch is lit, the corresponding Voice will sound by playing the keyboard. When the multiple indicator lamps are lit, those Voices will be layered.



Exiting from the Current Screen

The MENU screens and the SETTINGS screens are organized according to a hierarchical structure. Press the [EXIT] button to move one step back to the previous screen. Pressing the [EXIT] button several times will return you to the Top screen — in other words, the first one displayed when the instrument is turned on.

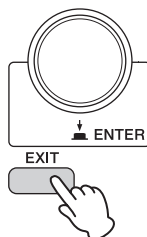

Display Configuration

This section explains the Top screen which appears when this instrument is turned on with its default settings (factory settings).

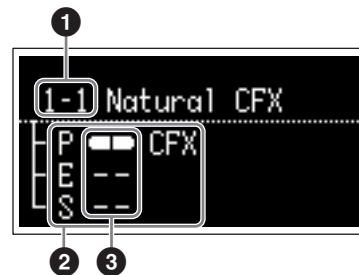

① Live Set Sound number

Displays Live Set Sound “1-1” when this instrument is turned on with default settings. You can change which Live Set Sound automatically appears on the Top screen by using the “Power On Sound” function (page 31).

② Voice section

Indicates Piano section (P), Electric piano section (E), Sub section (S), and displays the currently selected Voices for each of these Voice sections. The Voices of the Voice sections which are set to ON will be layered. Voices of Voice sections which are set to OFF will not sound, and no Voice name will be displayed.

③ Split

Indicates the current split status of each Voice section.

indicates that the Voice is assigned to a range below the split point.

indicates that the Voice is assigned to a range above the split point.

Editing File Names/Live Set Sound Names

■ Editing File Names

See “Saving the settings to a USB flash drive” on page 23.

■ Editing Live Set Sound Names

Select the desired Live Set Sound for which you wish to edit the name → [SETTINGS] button → “Name” → Edit the name → [STORE] button → [ENTER] button.

NOTE

The edited names will not be stored in this instrument unless you perform the Store operation with the [STORE] button.

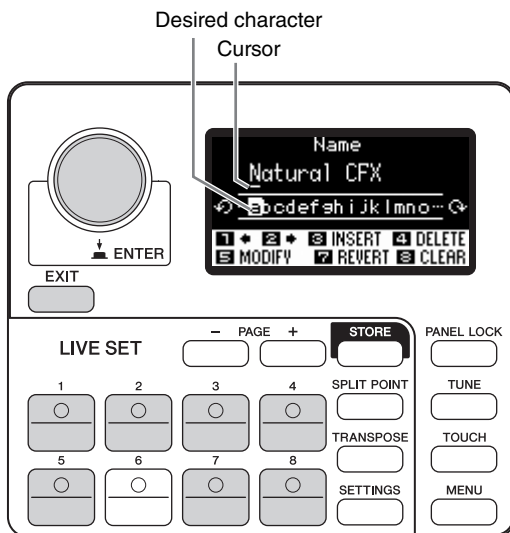

Use the Live Set Sound [1]/[2] buttons to move the cursor to the position of the character you wish to edit. Use the Encoder dial to select characters, and use the following buttons to edit the name.

Button/Indication	Functions
Live Set Sound [1] 1 +	Moves the cursor to left.
Live Set Sound [2] 2 +	Moves the cursor to right.
Live Set Sound [3] 3 INSERT	Inserts a desired character at the cursor position.
Live Set Sound [4] 4 DELETE	Deletes the character at the cursor position.
Live Set Sound [5] 5 MODIFY	Changes the character at the cursor position to the desired one.
Live Set Sound [7] 7 REVERT	Reverts all characters to unedited name.
Live Set Sound [8] 8 CLEAR	Deletes all characters.
[ENTER]/[EXIT]	Terminates the edit operation.

Saving / Loading Data

In the File screens ([MENU] button → “File”) you can transfer entire system settings and data (such as Live Sets and Live Set Sounds) between this instrument and an external USB flash drive connected to the USB [TO DEVICE] terminal. This section explains how to save/load the data to/from the user memory of this instrument.

Saving the settings to a USB flash drive

1. **Connect a USB flash drive to the USB [TO DEVICE] terminal of this instrument.**

2. **Call up the File screen.**

Press the [MENU] button, select “File,” and then press the [ENTER] button.

3. **Select the contents you wish to save.**

The following file types can be saved to a USB flash drive.

File type	Description
Back Up File	All data including the system settings stored in this instrument.
Live Set All File	All the Live Set Pages stored in this instrument.
Live Set Page File	A Live Set Page stored in this instrument.
Live Set Sound File	A Live Set Sound stored in this instrument.

4. **Call up the Save screen.**

Select “Save” and press the [ENTER] button.

■ Overwriting files

Select the file to be overwritten from the displayed list.

■ Saving as a new file

Select “New File,” and then the “Save Backup File” screen will appear. For details about how to edit file names, refer to the “Editing the File names/Live Set Sound names.”



File name edit screen

Loading the settings from a USB flash drive

NOTICE

The Load operation overwrites any data previously existing in this instrument. Important data should always be saved to a USB flash drive connected to the USB [TO DEVICE] terminal.

1. **Connect a USB flash drive to the USB [TO DEVICE] terminal of this instrument.**

2. **Call up the File screen.**

Press the [MENU] button, select “File,” and then press the [ENTER] button.

3. **Select the contents you wish to load from the USB flash drive.**

File type	Description
Back Up File (Extension: .X9A)	All data including system settings saved to the USB flash drive.
Live Set All File (Extension: .X9L)	All the Live Set Pages saved to the USB flash drive.
Live Set Page File (Extension: .X9P)	A Live Set Page saved to the USB flash drive. The file will be loaded to the currently selected Live Set Page.
Live Set Sound File (Extension: .X9S)	A Live Set Sound saved to the USB flash drive. The file will be loaded to the currently selected Live Set Sound.

4. **Select “Load” and press the [ENTER] button.**

Select the folder containing the file you wish to load, and then press the [ENTER] button.

5. **Select a file in the USB flash drive.**

The messages “Loading.” → “Completed.” will appear on the screen, and then return to the Top screen.

To cancel the loading operation, select “Cancel” and press the [ENTER] button.

Precautions when using the USB [TO DEVICE] terminal

This instrument features a built-in USB [TO DEVICE] terminal. When connecting a USB device to the terminal, be sure to handle the USB device with care. Follow the important precautions below.

NOTE

For more information about the handling of USB devices, refer to the owner's manual of the USB device.

■ Compatible USB devices

Only USB memory devices of the flash drive variety can be used with this instrument. Furthermore, this instrument does not necessarily support all commercially available USB flash drives, and Yamaha cannot guarantee normal operation with every such device on the market. Before purchasing a USB flash drive for use with this instrument, therefore, please visit the following web page to confirm whether or not it is supported:

<http://download.yamaha.com/>

Although USB devices 2.0 to 3.0 can be used on this instrument, the amount of time for saving to or loading from the USB device may differ depending on the type of data or the status of the instrument.

NOTE

The rating of the USB [TO DEVICE] terminal is a maximum of 5V/500mA. Do not connect USB devices having a rating above this, since they can cause damage to the instrument itself.

■ Connecting a USB device

When connecting a USB device to the USB [TO DEVICE] terminal, make sure that the connector on the device is appropriate and that it is connected in the proper direction.

■ Formatting a USB flash drive

Certain types of flash drive must be formatted before they can be used with this instrument. Whenever you plug such a device into the USB [TO DEVICE] terminal, and a "Connect USB device" message is shown prompting you to format it, do so.

NOTICE

The format operation overwrites any previously existing data. Make sure that the USB flash drive you are formatting does not contain important data.

■ Write protection

To prevent important data from being inadvertently erased, apply the write-protect provided with each USB flash drive. If you are saving data to the USB flash drive, make sure to disable write-protect.

■ Removing USB flash drives

Before removing a USB flash drive from the USB [TO DEVICE] terminal, ensure that this instrument is not currently accessing it in order to save, delete or load data.

NOTICE

Make sure to avoid excessive repeated connecting/disconnecting of USB flash drives. Failing to follow this may cause this instrument to freeze and stop operating. In addition, a USB flash drive should never be removed before it has been fully mounted or while it is being accessed by this instrument in order to load or save data. Data on the USB flash drive or on the instrument itself may be corrupted as a result of such action, and there is also a danger that the USB flash drive could be permanently damaged.

Using with Other MIDI Devices

By using standard MIDI cables (sold separately), you can connect other MIDI devices such as synthesizers and sound modules to this instrument via its MIDI [IN]/[OUT] terminals. This type of connection allows you to exchange MIDI data with these devices.

The MIDI [IN]/[OUT] terminals and the USB [TO HOST] terminal can be used for MIDI data transmission/reception. The illustrations below show examples of how to use the MIDI [IN]/[OUT] terminals.

NOTE

For instructions on setting the MIDI Port, refer to page 28.

Controlling a synthesizer or tone generator module from this instrument

This connection lets you play the sounds of an external MIDI tone generator (synthesizer, tone generator module, etc.) from this instrument's keyboard. Use this connection as well when you wish to have both instruments sound.

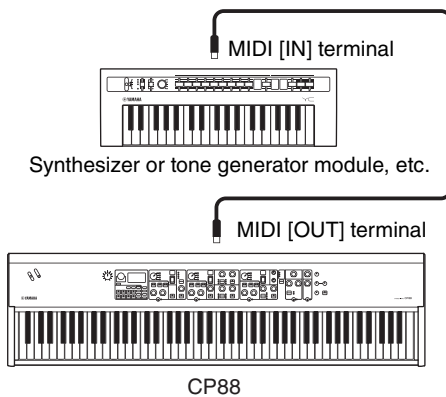

Controlling this instrument from an external MIDI keyboard or synthesizer

Use an external MIDI keyboard or synthesizer to remotely select and play the Voices of this instrument.

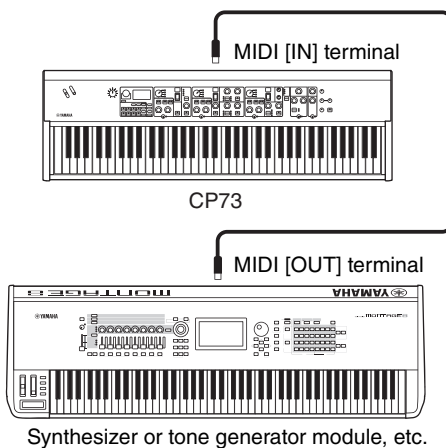

MIDI transmit and receive channels

Make sure to match the MIDI transmit channel of the external MIDI instrument with the MIDI receive channel of this instrument. For details on setting the MIDI transmit channel of the external MIDI instrument, refer to the owner's manual of that instrument. You can check and change the settings of MIDI receive channel of this instrument from the [MENU] button → "General" → "MIDI Settings" → "MIDI Channel" → "Rx."

If you wish to sound only the external MIDI instrument, turn down the master volume of this instrument, or set the "Local Control" to "Off" from the [MENU] button → "General" → "Local Control" (page 30).

For information on how to set the MIDI Receive Channel of the external MIDI instrument, refer to the owner's manual of that particular MIDI instrument.

MIDI channels and MIDI ports

MIDI data is assigned to one of sixteen channels, but this sixteen-channel limit can be overcome by using separate MIDI "ports," each supporting sixteen channels. This instrument uses two MIDI ports for the following applications.

■ Port 1

The tone generator block in this instrument can recognize and use only this port. When playing this instrument as a tone generator from the external MIDI instrument or computer, you should set the MIDI Port to 1 on the connected MIDI device or computer.

■ Port 2

This port is used as the MIDI Thru Port, allowing you to re-transmit MIDI data received by this instrument to an external MIDI device. This is useful, for example, when you want to connect an external MIDI device not having a USB terminal to a computer via this instrument, and so on. When you use this port, set “MIDI” to “Off” and “USB” to “On” from the [MENU] button → “General” → “MIDI Settings” → “MIDI Port.”

The MIDI data received via the USB [TO HOST] terminal will be re-transmitted to an external MIDI device via the MIDI [OUT] terminal. The MIDI data

received via the MIDI [IN] terminal will be re-transmitted to an external MIDI device via the USB [TO HOST] terminal.

When using a USB connection, make sure to match the MIDI transmit port and the MIDI receive port as well as the MIDI transmit channel and the MIDI receive channel. Make sure to set the MIDI port of the external device connected to this instrument according to the above information.

Using with a Computer

By connecting this instrument to your computer, you can use DAW or sequence software on the computer to create your own original songs and record complex arrangements.

DAW

The acronym DAW (Digital Audio Workstation) refers to music software for recording, editing and mixing audio and MIDI data. The main DAW applications include Cubase, Logic Pro, Ableton Live, and Pro Tools.

Here are some of the creative options you can explore when connecting this instrument to a computer:

- Use the instrument as an external sound source and/or MIDI keyboard for a DAW application.
- Record yourself playing this instrument in MIDI or audio format to a DAW application.

Connecting to a computer

A USB cable and the Yamaha Steinberg USB Driver are necessary to connect this instrument to the computer. Follow the instructions below. Note that both audio data and MIDI data can be transmitted through a USB cable. The following describes how this type of connection can be established:

1. Download the latest Yamaha Steinberg USB Driver from our website.

After clicking the Download button, extract the compressed file.

<http://download.yamaha.com/>

NOTE

- Information on system requirements is also available at the above website.
- The Yamaha Steinberg USB Driver may be revised and updated without prior notice. Make sure to check and download the latest version from the above site.

2. Install the Yamaha Steinberg USB Driver to the computer.

For instructions on installing, refer to the online Installation Guide included in the downloaded file package. When connecting this instrument to a computer, connect the USB cable to the USB [TO HOST] terminal of this instrument and the USB terminal of the computer as shown below.

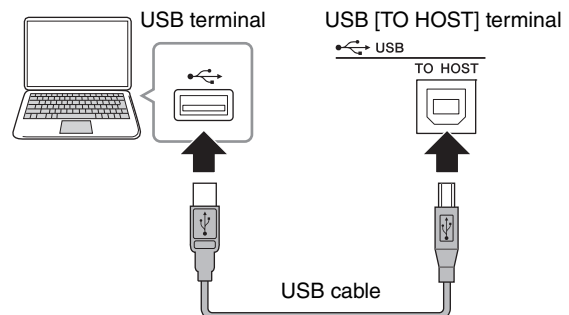

3. Set the MIDI port of this instrument.

[MENU] button → “General” → “MIDI Settings” → “MIDI Port” → “USB” → “On.”

Precautions when using the USB [TO HOST] terminal

When connecting the computer to the USB [TO HOST] terminal, make sure to observe the following points. Failing to do so risks freezing the computer and corrupting or losing the data. If the computer or the instrument freezes, restart the application software or the computer OS, or turn the power to the instrument off and then on again.

NOTICE

- Use an AB type USB cable. Do not use a USB 3.0 cable.
- Before connecting the computer to the USB [TO HOST] terminal, exit from any power-saving mode of the computer (such as suspend, sleep, standby).
- Before turning on the power to the instrument, connect the computer to the USB [TO HOST] terminal.
- Execute the following before turning the power to the instrument on/off or plugging/unplugging the USB cable to/from the USB [TO HOST] terminal.
 - Quit any open application software on the computer.
 - Make sure that data is not being transmitted from the instrument. (Note that even playing a key causes data to be sent.)
- When making computer connections, make sure that at least six seconds elapses between the time you turn this instrument on/off and you connect/disconnect the USB cable.

Connecting an iPhone or iPad

NOTE

In order to eliminate the risk of noise from other communication when using this instrument with an iPad or iPhone app, be sure to turn on Airplane Mode and then turn on Wi-Fi.

NOTICE

Be sure to place your iPad or iPhone on a stable surface to prevent it from falling over and being damaged.

Apps compatible with this instrument provide many more convenient and creative ways to enjoy music with it. For details on how to connect the devices, refer to the “iPhone/iPad Connection Manual,” which is available from the Yamaha website.

iPhone/iPad Connection Manual

This is downloadable from the Yamaha Downloads website:

<http://download.yamaha.com/>

Details of compatible smart devices and apps can be found on the following page at the Yamaha website.

<http://www.yamaha.com/kbdapps/>

USB Audio

USB Audio receiving/sending capability for the instrument is a maximum 2 channels (1 stereo channel) at a sampling rate of 44.1 kHz. The input signal from the USB [TO HOST] terminal is output via the OUTPUT [L]/[R] jacks (XLR type connector), the OUTPUT [L/MONO]/[R] jacks and the [PHONES] jack.

The input level can be adjusted from the [MENU] button → “General → “USB Audio Volume.”

The audio signal output via the USB [TO HOST] terminal is identical to the audio signal output via the OUTPUT [L]/[R] jacks (XLR type connector), the OUTPUT [L/MONO]/[R] jacks, and the [PHONES] jack.

NOTE

The audio signal input via the INPUT [L/MONO]/[R] jacks is output only from the OUTPUT [L]/[R] jacks (XLR type connector), the OUTPUT [L/MONO]/[R] terminal, and the [PHONES] jack of this instrument, and is not sent via the USB [TO HOST] terminal.

MENU LIST

From the [MENU] button, you can configure various parameters and functions over the whole system of this instrument. The settings will be stored in this instrument.

Operation

1. Press the [MENU] button.
2. Use the Encoder dial and the [ENTER] button to call up the item you wish to edit.
3. Use the Encoder dial to change the value or settings.
4. Press the [ENTER] button to execute the settings. The display will return to the Top screen.

General

Function name			Description
Master Tune			Determines the tuning for the entire instrument. Settings: 414.72 Hz – 466.78 Hz Default: 440.00 Hz
MIDI Settings	MIDI Port	USB	Determines whether to use (On) the USB [TO HOST] terminal as the input/output ports for MIDI message, or not (Off). Default: On NOTE The USB port 1 will be used when this is set to “On”
		MIDI	Determines whether to use (On) the MIDI [IN]/[OUT] terminals as the input/output ports for MIDI messages, or not (Off). When this is set to “On,” the terminals will be enabled. When this is set to “Off,” MIDI messages received via the MIDI terminals will be output to USB port 2. MIDI messages received via USB port 2 will be output to the MIDI terminals. Default: On
MIDI Channel	Tx		Determines the MIDI transmit channel. When this is set to “Off,” MIDI messages are not transmitted. Settings: 1 – 16, Off Default: 1
		Rx	Determines the MIDI receive channel. When this is set to “All,” MIDI messages will be received over all channels. Settings: 1 – 16, All Default: 1
MIDI Control			Determines how the instrument performs and responds to MIDI control. When this is set to “On,” control change messages dedicated to the CP88 and CP73 will be transmitted from the effective controls, allowing you to control DAW software or an external MIDI device from this instrument. When these messages are received (for example, from DAW playback), the settings of the relevant, corresponding controls will be changed. Controls that can be changed are indicated by the lit knobs and switches. When this is set to “Invert,” control change messages from the sections not being used can be transmitted or received. For example, when you’ve created a Live Set Sound of Piano and Strings from DAW software, you can assign the Sub section controls to affect the volume or filter of a strings instrument in DAW software. Default: Off NOTE Control change messages corresponding to the controls of this instrument cannot be changed. If you wish to re-assign specific parameters of DAW software for control, set them up on your computer (page 26).

Function name		Description
MIDI Settings	MIDI Control	<p>■ MIDI Control = On Control change messages from the enabled controls of this instrument can be transmitted or received.</p> <p>NOTE Since the control lights will be lit according to the settings of “Display Lights” (page 30), even when the Voice section [ON/OFF] switches or the Insertion effect [ON/OFF] buttons are set to OFF, the control change messages will be transmitted or received.</p> <p>■ MIDI Control = Off Control change messages cannot be transmitted or received, regardless of the state of the controls.</p> <p>■ MIDI Control = Invert The section lamps are lit and all controls are enabled. Control change messages can be transmitted or received, only when the Voice section [ON/OFF] switches are set to OFF.</p> <p>NOTE When this is set to “Invert,” the section lamps are automatically lit, so the “Display Lights” (“Section” and “Ins Effect” only) settings cannot be made.</p>
	Tx/Rx Pgm Change	<p>Determines whether transmission/reception of program change messages between this instrument and external MIDI devices is enabled (On) or disabled (Off). Default: On</p>
	Tx/Rx Bank Select	<p>Determines whether transmission/reception of bank select messages between this instrument and external MIDI devices is enabled (On) or disabled (Off). Default: On</p>
	Controller Reset	<p>Determines the status of the controllers (Modulation lever, Foot Controller, etc.) when switching between Live Set Sounds. When this is set to “Hold,” the controllers are kept at the current setting. When this is set to “Reset,” the controllers are reset to the default states (below).</p> <ul style="list-style-type: none"> • Pitch Bend: Center • Modulation lever: Minimum • Expression: Maximum • Pedal Wah: Minimum <p>Default: Reset</p>
Keyboard/ Pedal	Octave	<p>Shifts the octave range of the keyboard up or down. Settings: -3 – +3 Default: +0</p>
	Transpose	<p>Transposes the pitch of the keyboard up or down in semitones. Settings: -12 – +12 Default: +0</p>
	Touch Curve	<p>Determines how actual note velocities will be generated and transmitted according to the strength of your playing. Settings: Normal, Soft, Hard, Wide, Fixed Default: Normal</p>
	Fixed Velocity	<p>Use this function to send a fixed velocity to the tone generator regardless of how strongly or softly you play the keyboard. This parameter is only available if you select the “Fixed” Touch Curve above. Settings: 1 – 127 Default: 64</p>

Function name		Description
Keyboard/ Pedal	Sustain Pedal Type	Determines which type of foot switch connected to the FOOT SWITCH [SUSTAIN] jack is recognized. Select “FC3A (HalfOn)” when you wish to use half-damper playing techniques. Settings: FC3A (HalfOn), FC3A (HalfOff), FC4A/FC5 Default: FC3A (HalfOn)
	Foot Switch Assign	Determines the Control Change number generated by using the Footswitch connected to the FOOT SWITCH [ASSIGNABLE] jack. Keep in mind that if the same MIDI Control Change messages set here are received from an external device, the internal tone generator also responds to those messages as if the Footswitch of the instrument itself was used. Default: Live Set +
Local Control		Determines local control on and off. When “Off” is selected, this instrument’s tone generator is essentially disconnected from its controllers, and no sound will be produced in response to playing of the keyboard. This instrument does, however, continue to transmit MIDI messages when “Local Control” has been set to “Off,” and the tone generator will continue to produce sound in response to received MIDI messages. Default: On
USB Audio Volume		Determines the output level of the USB Audio. Settings: 0 – 127 Default: 64
Auto Power Off		Determines whether to set the Auto Power Off function to “Enable” or “Disable.” Default: Disable

Control Panel

Function name		Description
Panel Lock Settings	Live Set	Determines whether to enable (On) or disable (Off) the panel lock for each of the categories listed at left. Default: On
	Piano/E.Piano/Sub	
	Delay/Reverb	
	Master EQ	
Display Lights	Section	Determines whether or not the lighting of the indicator lamps for the Piano, Electric piano, Sub, Delay, Reverb sections is linked with each section’s [ON/OFF] switches. When “Off” is selected, the corresponding lamps are linked with each of the [ON/OFF] switches; when “On” is selected, the indicator lamps will always be lit. When “MIDI Control” is set to “On,” the transmit/receive settings of control change messages will be changed according to the state of the indicator lamps (page 28). Default: Off
	Ins Effect	Determines whether or not the lighting of the indicator lamps of insertion effects contained in Voice sections is linked with each Insertion effect’s [ON/OFF] buttons. When “Off” is selected, the corresponding indicator lamps are linked with each of the [ON/OFF] buttons; when “On” is selected, the indicator lamps will always be lit. Default: Off

Function name		Description
Display Lights	LCD SW	Determines whether to show (On) or not show (Off) the Top screen. The various setting screens such as the MENU screens and the SETTINGS screens are always shown regardless of this setting. Default: On
	LCD Contrast	Adjusts the contrast of this instrument's LCD. Settings: 1 – 63 Default: 32
Advanced Settings	Section Hold	When this is set to "Enable," you can select another Live Set Sound and still maintain (hold) selected settings of the currently selected Live Set Sound. To maintain the settings of the desired sections, press and hold the section [ON/OFF] switches until the corresponding indicator lamp flashes. To release Section Hold, press the section [ON/OFF] switches again. For example, to fix the reverb settings during your performance regardless of the Live Set Sound, set "Section Hold" to "Enable" and then push and hold the Reverb section [ON/OFF] switch. Default: Disable
	Live Set View Mode	Determines whether to maintain the Live Set View (Keep) or return to the Top screen (Close) when switching between Live Set Sounds. When this is set to "Keep," eight sets of Live Set Sounds are displayed in one screen. Default: Close
	Value Indication	Determines whether to display (On) the values of each knobs on LCD, or not (Off). Default: On
	SW Direction	Determines whether to operate the Voice select switches in ascending order (Default) or in descending order (Reverse). Default: Default
	Power On Sound	Determines which Live Set Sound is automatically shown on the Top screen when this instrument is turned on. Default: 1-1
	MIDI Device Number	Determines the MIDI device numbers. The device number of this instrument must match the device number of the external MIDI device when transmitting/receiving bulk data, parameter changes or other system exclusive messages. Settings: 1 – 16, All, Off Default: All

Job

Function name		Description
Live Set Manager	Swap	Swaps the currently selected Live Set Sound with an arbitrary Live Set Sound.
	Copy	Copies the currently selected Live Set Sound and paste it onto arbitrary Live Set Page and the position.
	Initialize	Resets the currently selected Live Set Sound to its default value.

Function name		Description	
Section Manager	Copy	Piano	Copies the settings of the currently selected Piano section.
		E.Piano	Copies the settings of the currently selected Electric piano section.
		Sub	Copies the settings of the currently selected Sub section.
	Paste	Piano	Pastes the settings of the previously copied Voice section. This function cannot be executed when no Voice section has been previously copied or when a different Voice section is selected as the paste destination.
		E.Piano	
		Sub	
Edit Recall	Recall	If, while editing a Live Set Sound you have not yet stored, you select a different Live Set Sound and then return to the one being edited, the latest stored version will be selected. Using this function, you can restore your latest edits and keep them intact. NOTICE Keep in mind that all of your latest edits (unsaved) will be lost when this instrument is turned off.	
Menu Initialize		Resets the settings of MENU screens to the default values.	
Factory Reset		Restores this instrument to its default (factory) condition.	

File

Function name		Description
Back Up File	Save	Saves all the data stored in this instrument including the system settings to a USB flash drive as a "Back Up File" (with the extension: .X9A).
	Load	Loads the data saved as a "Back Up File" from a USB flash drive.
Live Set All File	Save	Saves all the Live Set data stored in this instrument to a USB flash drive as a "Live Set All File" (with the extension: .X9L).
	Load	Loads the data saved as a "Live Set All File" from a USB flash drive.
Live Set Page File	Save	Saves a Live Set Page stored in this instrument to a USB flash drive as a "Live Set Page File" (with the extension: .X9P).
	Load	Loads the data saved as a "Live Set Page File" from a USB flash drive.
Live Set Sound File	Save	Saves a Live Set Sound stored in this instrument to a USB flash drive as "Live Set Sound File" (with the extension: .X9S).
	Load	Loads the data saved as a "Live Set Sound File" from a USB flash drive.
File Utility	Rename	Renames a file name in a USB flash drive.
	Delete	Deletes a file in a USB flash drive.
	Format	Initializes a USB flash drive. NOTICE When a USB flash drive is formatted, all of its content will be deleted. Because of this, make sure before formatting that the USB flash drive contains no irreplaceable data.

Version Info

Shows the versions of this instrument's boot loader and firmware as well as the owner of the copyright for this instrument.

SETTINGS LIST

From the [SETTINGS] button, you can configure and store the various settings of the currently selected Live Set Sound. The settings will be stored in this instrument.

Operation

1. Press the [SETTINGS] button.
2. Use the Encoder dial and the [ENTER] button to call up the item you wish to edit.
3. Use the Encoder dial to change the value or settings.
4. Press the [ENTER] button to execute the settings. The display will return to the Top screen.

Function

Function name	Description
Sound Transpose	Transposes the pitch in semitones. Settings: -12 – +12 Default: +0 NOTE This setting does not affect the MIDI output data.
Split Point	Determines the note that separates (splits) the left hand section and the right hand section. The Split Point is the lowest note of the right hand section. Settings: C#-2 – G8 Default: G2

Master Keyboard

With the Master Keyboard function, you can configure this instrument for use as a master keyboard, for complex live performance features. It allows the keyboard to be split into as many as four different zones, each of which can control separate sounds of an external tone generator. For example, you can make a Live Set Sound combining Voices from this instrument and the external tone generators, or Live Set Sound composed with Voices of external tone generators only.

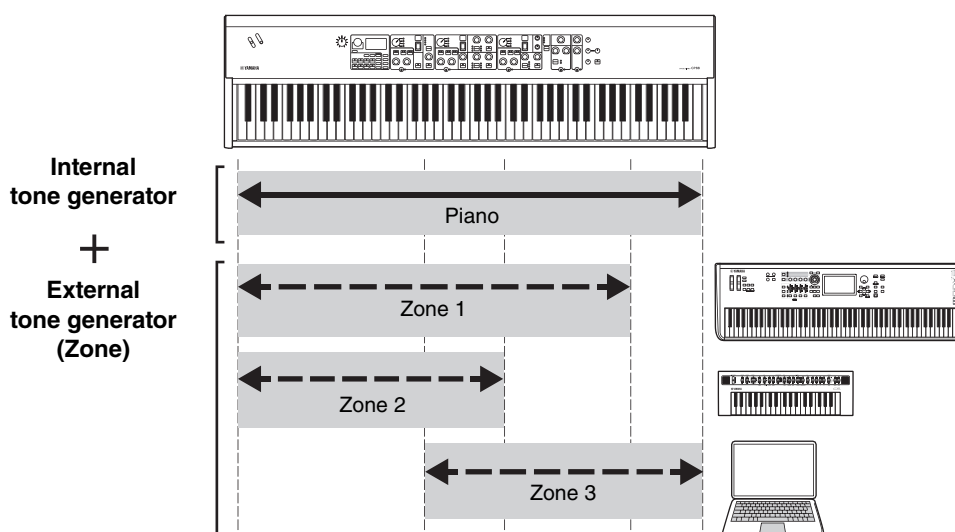

Function name		Description
Mode SW		Switches the Master Keyboard Mode settings. When “On” is selected, the Master Keyboard Mode is enabled, and the [MKT] indication appears on the Live Set screen. Default: Off
Advanced Zone SW		Switches the setting range of Master Keyboard Mode. When “On” is selected, you can make detailed settings. Default: Off NOTE When “Off” is selected, the detailed settings will not be displayed.
Zone Settings *: Detailed settings	Zone Switch	Determines whether to enable (On) or disable (Off) the currently selected zone. Default: On
	Tx Channel	Determines the MIDI transmit channel for the currently selected zone. Settings: 1 – 16 Default: 1
	Octave Shift	Shifts the pitch of the currently selected zone in units of one octave. Settings: -3 – +3 Default: +0
	Transpose	Transposes the pitch of the currently selected zone in semitone units. Settings: -11 – +11 Default: +0
	Note Limit Low	Determines the lowest key in the currently selected zone. Default: C -2
	Note Limit High	Determines the highest key in the currently selected zone. Default: G8
	Bank MSB*	Determines the Bank Select MSB to be sent as a MIDI message from the currently selected zone to the corresponding external instrument upon selection of a Live Set Sound. Default: 0
	Bank LSB*	Determines the Bank Select LSB to be sent as a MIDI message from the currently selected zone to the corresponding external instrument upon selection of a Live Set Sound. Default: 0
	Program Change*	Determines the Program Change Number to be sent as a MIDI message from the currently selected zone to the corresponding external instrument upon selection of the Live Set Sound. Default: 1
	Volume*	Determines the volume of the external instrument corresponding to the currently selected zone upon selection of the Live Set Sound. Default: 100
	Pan*	Determines the stereo panning of the external instrument corresponding to the currently selected zone upon selection of the Live Set Sound. Default: C
	Tx SW Note*	Determines whether to enable (On) or disable (Off) the sending of MIDI note messages from the currently selected zone to the corresponding external instrument. Default: On
Tx SW Bank*	Determines whether to enable (On) or disable (Off) the sending of MIDI Bank Select messages from the currently selected zone to the corresponding external instrument. Default: On	

Function name		Description
Zone Settings	Tx SW Program*	Determines whether to enable (On) or disable (Off) the sending of MIDI Program Change messages to the external instrument corresponding to the currently selected zone. Default: On
	Tx SW Volume*	Determines whether to enable (On) or disable (Off) the sending of MIDI Volume messages to the external instrument corresponding to the currently selected zone. Default: On
	Tx SW Pan*	Determines whether to enable (On) or disable (Off) the sending of MIDI Pan messages to the external instrument corresponding to the currently selected zone. Default: On
	Tx SW PB*	Determines whether to enable (On) or disable (Off) the sending of MIDI Pitch Bend messages to the external instrument corresponding to the currently selected zone. Default: On
	Tx SW MOD*	Determines whether to enable (On) or disable (Off) the sending of MIDI Modulation messages to the external instrument corresponding to the currently selected zone. Default: On
	Tx SW Sustain*	Determines whether to enable (On) or disable (Off) the sending of MIDI Sustain messages to the external instrument corresponding to the currently selected zone. Default: On
	Tx SW FS*	Determines whether to enable (On) or disable (Off) the sending of MIDI messages from the footswitch to the external instrument corresponding to the currently selected zone. Default: On
	Tx SW FC1*	Determines whether to enable (On) or disable (Off) the sending of MIDI messages from FOOT CONTROLLER [1] to the external instrument corresponding to the currently selected zone. Default: On
	Tx SW FC2*	Determines whether to enable (On) or disable (Off) the sending of MIDI messages from FOOT CONTROLLER [2] to the external instrument corresponding to the currently selected zone. Default: On

Advanced Mode

The Advanced Mode lets you use the Voice select switch to select any Voice from any Voice section, no matter the category. For example, you can combine a Voice of Piano section and Wah (insertion effect) of Electric piano section, or make one Voice to be layered.

Function name		Description
Advanced Mode SW	Piano	Determines whether to enable (On) or disable (Off) the Advanced Mode for each Voice section. When this is set to "On," the ADV indication appears on the Top screen. Default: Off NOTE When this is set to "On," the Voice number will not be displayed on the Voice number display, but the Voice name will be displayed on the LCD.
	E.Piano	
	Sub	

Controllers

Function name		Description	
Bend Range	Piano	Determines the maximum Pitch Bend Range in semitones for each Voice section. Settings: -24 – +0 – +24 Default: +2	
	E.Piano		
	Sub		
P.Mod Depth	Piano	Determines the depth of vibrato effect on keyboard sound. This can be set individually for each Voice section. Settings: 0 – 127 Piano/E.Piano default: 0 Sub default: 10 NOTE Since the vibrato effect is disabled when a “Rotary” effect of the Sub section is selected, this setting will also be disabled.	
	E.Piano		
	Sub		
FC1 Assign		MIDI control change numbers produced by operating a foot controller (sold separately) connected via the FOOT CONTROLLER [1] jack. Default: 11 (Expression)	
FC2 Assign		MIDI control change numbers produced by operating a foot controller (sold separately) connected via the FOOT CONTROLLER [2] jack. Default: 4 (Pedal Wah)	
Receive SW	Expression	Piano	Determines whether to recognize (On) or ignore (Off) the corresponding MIDI messages received by each Voice section from external devices or the MIDI messages produced by operating a foot switch and foot controller. Default: On
		E.Piano	
		Sub	
	Sustain	Piano	
		E.Piano	
		Sub	
	Sostenuto	Piano	
		E.Piano	
		Sub	
	Soft	Piano	
		E.Piano	
		Sub	

Name

Edits the names of Live Set Sounds. For detailed instructions on editing, refer to “Editing File Names/Live Set Sound Names” (page 22) .

NOTE

To store the edited names, you’ll need to use the Store operation (page 12).

DATA LIST

Live Set Sound List

BANK	No	Name	Split Point	Section	Voice Name	MSB	LSB	PC
1	1	Natural CFX	G2	Piano	CFX	63	0	1
				E.Piano	-			
				Sub	-			
1	2	NaturalImperial	G2	Piano	Imperial	63	0	2
				E.Piano	-			
				Sub	-			
1	3	Jazz S700	G2	Piano	S700	63	0	3
				E.Piano	-			
				Sub	-			
1	4	Rock Upright	G2	Piano	U1	63	0	4
				E.Piano	-			
				Sub	-			
1	5	Simple 78	G2	Piano	-	63	0	5
				E.Piano	78Rd			
				Sub	-			
1	6	Funky Tines	G2	Piano	-	63	0	6
				E.Piano	75Rd Funky			
				Sub	-			
1	7	Tremolo Wr	G2	Piano	-	63	0	7
				E.Piano	Wr Warm			
				Sub	-			
1	8	Clavi B Amped	G2	Piano	-	63	0	8
				E.Piano	Clavi B			
				Sub	-			
2	1	CFX+DX Legend	G2	Piano	CFX	63	1	1
				E.Piano	DX Legend			
				Sub	-			
2	2	A.Bass/78Rd	G2	Piano	U1	63	1	2
				E.Piano	78Rd			
				Sub	A.Bass			
2	3	80s El Grand	G2	Piano	CP80 1	63	1	3
				E.Piano	-			
				Sub	-			
2	4	Brite Pop 8ve	G2	Piano	Digi Piano	63	1	4
				E.Piano	DX Legend			
				Sub	OB Strings			
2	5	E.Bass/78Rd	G2	Piano	-	63	1	5
				E.Piano	78Rd			
				Sub	E.Bass			
2	6	Driven Wr+Pad	G2	Piano	-	63	1	6
				E.Piano	Wr Warm			
				Sub	Warm Strings			
2	7	Imperial + Str	G2	Piano	Imperial	63	1	7
				E.Piano	-			
				Sub	Section Str			
2	8	Ghostly U1	G2	Piano	U1	63	1	8
				E.Piano	Wr Warm			
				Sub	-			
3	1	Rock Grand	G2	Piano	CFX	63	2	1
				E.Piano	-			
				Sub	-			
3	2	S700 + Pad	G2	Piano	S700	63	2	2
				E.Piano	-			
				Sub	OB Strings			
3	3	MonoCmp CFX	G2	Piano	CFX	63	2	3
				E.Piano	-			
				Sub	-			
3	4	Lo Fi Grand	G2	Piano	CFX	63	2	4
				E.Piano	-			
				Sub	-			
3	5	Piano Grind Pad	G2	Piano	Piano Synth	63	2	5
				E.Piano	73Rd			
				Sub	Mellow Pad			
3	6	Lush Love	G2	Piano	Imperial	63	2	6
				E.Piano	78Rd			
				Sub	Brightness			

BANK	No	Name	Split Point	Section	Voice Name	MSB	LSB	PC
3	7	Big S700	G2	Piano	S700	63	2	7
				E.Piano	73Rd			
				Sub	OB Strings			
3	8	Piano Scape	G2	Piano	Imperial	63	2	8
				E.Piano	DX Legend			
				Sub	Mellow Pad			
4	1	Compressed CFX	G2	Piano	CFX	63	3	1
				E.Piano	-			
				Sub	-			
4	2	Kinda Squashed	G2	Piano	Imperial	63	3	2
				E.Piano	-			
				Sub	-			
4	3	Layered CFX	G2	Piano	CFX	63	3	3
				E.Piano	75Rd Funky			
				Sub	Mellow Pad			
4	4	Chorus CFX	G2	Piano	CFX	63	3	4
				E.Piano	-			
				Sub	-			
4	5	Upright	G2	Piano	U1	63	3	5
				E.Piano	-			
				Sub	-			
4	6	A Tacky Piano	G2	Piano	SU7	63	3	6
				E.Piano	75Rd Funky			
				Sub	Brightness			
4	7	HonkyTonk Piano	G2	Piano	U1	63	3	7
				E.Piano	-			
				Sub	-			
4	8	Old Record	G2	Piano	U1	63	3	8
				E.Piano	-			
				Sub	-			
5	1	Case 73	G2	Piano	-	63	4	1
				E.Piano	73Rd			
				Sub	-			
5	2	Chimin' Tines	G2	Piano	Digi Piano	63	4	2
				E.Piano	78Rd			
				Sub	Glocken			
5	3	Slow Phase	G2	Piano	-	63	4	3
				E.Piano	73Rd			
				Sub	-			
5	4	73 Tines OD	G2	Piano	-	63	4	4
				E.Piano	73Rd			
				Sub	-			
5	5	Fast Phaser	G2	Piano	-	63	4	5
				E.Piano	75Rd Funky			
				Sub	-			
5	6	Ampy Funk	G2	Piano	-	63	4	6
				E.Piano	75Rd Funky			
				Sub	-			
5	7	Wet Phase	G2	Piano	-	63	4	7
				E.Piano	78Rd			
				Sub	-			
5	8	78 & Pad	G2	Piano	-	63	4	8
				E.Piano	78Rd			
				Sub	Mellow Pad			
6	1	Wr Bright	G2	Piano	-	63	5	1
				E.Piano	Wr Bright			
				Sub	-			
6	2	Wr Comp	G2	Piano	-	63	5	2
				E.Piano	Wr Warm			
				Sub	-			
6	3	Clavi B	G2	Piano	-	63	5	3
				E.Piano	Clavi B			
				Sub	-			
6	4	Driven S	G2	Piano	-	63	5	4
				E.Piano	Clavi S			
				Sub	-			

DATA LIST

BANK	No	Name	Split Point	Section	Voice Name	MSB	LSB	PC
6	5	Clavi Wah Dist	G2	Piano	-	63	5	5
				E.Piano	Clavi B			
				Sub	-			
6	6	Squeeze B	G2	Piano	-	63	5	6
				E.Piano	Clavi B			
				Sub	-			
6	7	Long Chorus S	G2	Piano	-	63	5	7
				E.Piano	Clavi S			
				Sub	-			
6	8	Rock Wr w/Ba	G2	Piano	Digi Piano	63	5	8
				E.Piano	Wr Bright			
				Sub	E.Bass			
7	1	CP80 Comp	G2	Piano	CP80 1	63	6	1
				E.Piano	-			
				Sub	-			
7	2	Natural CP80	G2	Piano	CP80 2	63	6	2
				E.Piano	-			
				Sub	-			
7	3	Chorus Legend	G2	Piano	-	63	6	3
				E.Piano	DX Legend			
				Sub	-			
7	4	Chorus FTine	G2	Piano	-	63	6	4
				E.Piano	DX FTine			
				Sub	Mellow Pad			
7	5	Chorus 7II	G2	Piano	-	63	6	5
				E.Piano	DX 7 II			
				Sub	-			
7	6	Legend + Pad	G2	Piano	-	63	6	6
				E.Piano	DX Legend			
				Sub	OB Strings			
7	7	SynBass/DXEP	G2	Piano	-	63	6	7
				E.Piano	DX Mellow			
				Sub	Syn Bass			
7	8	Digi DX Pads	G2	Piano	Digi Piano	63	6	8
				E.Piano	DX Legend			
				Sub	Mellow Pad			
8	1	Bright Bars	G2	Piano	-	63	7	1
				E.Piano	-			
				Sub	Bright Bars			
8	2	All Bars Out	G2	Piano	-	63	7	2
				E.Piano	-			
				Sub	All Bars Out			
8	3	PipeOrgan1	G2	Piano	-	63	7	3
				E.Piano	-			
				Sub	Pipe Organ 1			
8	4	PipeOrgan2	G2	Piano	-	63	7	4
				E.Piano	-			
				Sub	Pipe Organ 2			
8	5	The Red Combo	G2	Piano	-	63	7	5
				E.Piano	-			
				Sub	60s Combo			
8	6	Italian Combo	G2	Piano	-	63	7	6
				E.Piano	-			
				Sub	Compact			
8	7	Aggro Syn Pad	G2	Piano	-	63	7	7
				E.Piano	78Rd			
				Sub	Panther			
8	8	RdBa/60sCombo	G2	Piano	-	63	7	8
				E.Piano	78Rd			
				Sub	60s Combo			
9	1	Strings1	G2	Piano	-	63	8	1
				E.Piano	-			
				Sub	Natural Str			
9	2	Strings2	G2	Piano	-	63	8	2
				E.Piano	-			
				Sub	Section Str			
9	3	Synth Pad1	G2	Piano	-	63	8	3
				E.Piano	-			
				Sub	Mellow Pad			
9	4	Synth Pad2	G2	Piano	-	63	8	4
				E.Piano	-			
				Sub	Warm Strings			
9	5	Vibraphone	G2	Piano	-	63	8	5
				E.Piano	-			
				Sub	Vibraphone			
9	6	Nice Bell	G2	Piano	-	63	8	6
				E.Piano	-			
				Sub	Nice Bell			

BANK	No	Name	Split Point	Section	Voice Name	MSB	LSB	PC
9	7	Syn Brass	G2	Piano	-	63	8	7
				E.Piano	-			
				Sub	Syn Brass			
9	8	Syn Lead1	G2	Piano	-	63	8	8
				E.Piano	78Rd			
				Sub	Syn Lead 1			
10	1	Harpsichord	G2	Piano	-	63	9	1
				E.Piano	Harpsichord			
				Sub	-			
10	2	Electric Harpsi	G2	Piano	-	63	9	2
				E.Piano	Harpsichord			
				Sub	-			
10	3	Pipes Rd PBMW	G2	Piano	Digi Piano	63	9	3
				E.Piano	78Rd			
				Sub	Pipe Organ 2			
10	4	Funky w/RdBass	G2	Piano	CP80 1	63	9	4
				E.Piano	78Rd			
				Sub	Marimba			
10	5	Rough Lead	G2	Piano	CP80 2	63	9	5
				E.Piano	78Rd			
				Sub	Back Pad			
10	6	Clavi Syn Wah	G2	Piano	-	63	9	6
				E.Piano	Clavi B			
				Sub	Syn Lead 1			
10	7	Chimin' Crs	G2	Piano	Digi Piano	63	9	7
				E.Piano	75Rd Funky			
				Sub	Glocken			
10	8	Brite Pop	G2	Piano	Digi Piano	63	9	8
				E.Piano	DX Legend			
				Sub	OB Strings			

Voice List

Section	Category	No.	Voice	CC Value	
PIANO	Grand Piano	01	CFX	1	
		02	Imperial	2	
		03	S700	3	
		04	Digi Piano	4	
	Upright Piano	01	U1	5	
		02	SU7	6	
	CP	01	CP80 1	7	
		02	CP80 2	8	
	Special Piano	01	Piano Strings	9	
		02	Piano Synth	10	
E.PIANO	Rd	01	78Rd	11	
		02	75Rd Funky	12	
		03	73Rd	13	
	Wr	01	Wr Warm	14	
		02	Wr Bright	15	
	Clv	01	Clavi B	16	
		02	Clavi S	17	
		03	Harpsichord	18	
	DX	01	DX Legend	19	
		02	DX Woody	20	
		03	DX FTine	21	
		04	DX 7 II	22	
		05	DX Mellow	23	
		06	DX Crisp	24	
	SUB	Pad/Strings	01	Mellow Pad	25
			02	Spectrum	26
			03	Back Pad	27
			04	Air Choir	28
05			Natural Str	29	
06			Warm Strings	30	
07			OB Strings	31	
08			Section Str	32	
Organ		01	Bright Bars	33	
		02	Click Organ	34	
		03	Draw Organ 1	35	
		04	All Bars Out	36	
		05	Draw Organ 2	37	
		06	60s Combo	38	
		07	Compact	39	
		08	Panther	40	
		09	Pipe Organ 1	41	
		10	Pipe Organ 2	42	
Chromatic Perc.		01	Glocken	43	
		02	Vibraphone	44	
		03	Xylophone	45	
		04	Marimba	46	
		05	Brightness	47	
		06	Nice Bell	48	
		07	Stack Bell	49	
Others		01	Syn Lead 1	50	
		02	Syn Lead 2	51	
		03	Syn Bass	52	
		04	E.Bass	53	
		05	A.Bass	54	
		06	Steel Gt	55	
		07	Clean Gt	56	
	08	Syn Brass	57		

Control Change Number List

P:=Piano, E:=Electric Piano, S:=Sub
 Parameters shown within parentheses do not affect the sound of this instrument.
 * Only affected by foot switch, and not foot controller.
 *Parameter value/Controller value Correspondence Table (page 41)

	CC No. (LCD indication)	Panel controls	Table*	
Piano	12 P: Select	18 Voice category selector	M	
		19 Voice select switch	M	
	13 P: Volume	23 [VOLUME] knob	A	
	14 P: Tone	24 [TONE] knob	A	
	15 P: Damper Reso	25 DAMPER RESONANCE [ON/OFF] button	B	
	16 P: Effect SW	26 Insertion effect [ON/OFF] button	B	
	17 P: Effect Depth	28 [DEPTH] knob	A	
	77 P: Delay Depth	44 [DEPTH] knob	A	
	81 P: Reverb Depth	48 [DEPTH] knob	A	
	102 P: SW	17 Voice section [ON/OFF] switch	B	
	103 P: Split	21 SPLIT [L R] button	E	
	104 P: Octave	22 OCTAVE [-2 -1]/[+1 +2] buttons	F	
	105 P: Effect Type	27 Insertion effect switch button	G	
	E.Piano	18 E: Select	18 Voice category selector	N
			19 Voice select switch	N
19 E: Volume		23 [VOLUME] knob	A	
20 E: Tone		24 [TONE] knob	A	
21 E: Drive SW		26 Insertion effect [ON/OFF] button	B	
22 E: Drive Depth		29 [DRIVE] knob	A	
23 E: Effect 1 SW		26 Insertion effect [ON/OFF] button	B	
24 E: Effect 1 Depth		31 [DEPTH] knob	A	
25 E: Effect 1 Rate		32 [RATE] knob	A	
26 E: Effect 2 SW		26 Insertion effect [ON/OFF] button	B	
27 E: Effect 2 Depth		34 [DEPTH] knob	A	
28 E: Effect 2 Speed		35 [SPEED] knob	A	
78 E: Delay Depth		44 [DEPTH] knob	A	
82 E: Reverb Depth		48 [DEPTH] knob	A	
106 E: SW		17 Voice section [ON/OFF] switch	B	
107 E: Split		21 SPLIT [L R] button	E	
108 E: Octave		22 OCTAVE [-2 -1]/[+1 +2] buttons	F	
109 E: Effect 1 Type		30 Insertion effect switch button	H	
110 E: Effect 2 Type		33 Insertion effect switch button	I	
Sub		29 S: Select	18 Voice category selector	O
	19 Voice select switch		O	
	30 S: Volume	23 [VOLUME] knob	A	
	31 S: Tone	24 [TONE] knob	A	
	68 S: Effect SW	26 Insertion effect [ON/OFF] button	B	
	72 S: Release	37 [RELEASE] knob	A	
	73 S: Attack	38 [ATTACK] knob	A	
	75 S: Effect Depth	39 [DEPTH] knob	A	
	76 S: Effect Speed	40 [SPEED] knob	A	
	79 S: Delay Depth	44 [DEPTH] knob	A	
	83 S: Reverb Depth	48 [DEPTH] knob	A	
	111 S: SW	17 Voice section [ON/OFF] switch	B	
	112 S: Split	21 SPLIT [L R] button	E	
	113 S: Octave	22 OCTAVE [-2 -1]/[+1 +2] buttons	F	
114 S: Effect Type	33 Insertion effect switch button	J		
DELAY REVERB	80 Delay Time	46 [TIME] knob	A	
	85 Reverb Time	49 [TIME] knob	A	
	91 All Reverb Depth	48 [DEPTH] knob	A	
	92 Delay Feedback	45 [FEEDBACK] knob	A	
	93 All Delay Depth	44 [DEPTH] knob	A	
	115 Delay SW	42 DELAY [ON/OFF] switch	B	
	116 Delay Effect Type	43 [Analog/Digital] switch button	K	
	117 Reverb SW	47 REVERB [ON/OFF] switch	B	
	118 Depth Knob Select	41 Effect level display switch button	L	
	MASTER EQUALIZER	86 Master EQ SW	50 MASTER EQUALIZER [ON/OFF] button	B
87 Master EQ High		51 [HIGH] knob	C	
88 Master EQ Mid		52 [MID] knob	C	
89 Master EQ Freq		53 [FREQUENCY] knob	D	
90 Master EQ Low		54 [LOW] knob	C	

	CC No. (LCD indication)	Panel controls	Table*
PEDAL	1 Modulation		
	4 Pedal Wah		
	5 (Portamento Time)		
	6 (Data Entry MSB)		
	7 All Volume		
	10 (Pan)		
	11 Expression		
	12 P: Select	18 Voice category selector	M
		19 Voice select switch	M
	13 P: Volume	23 [VOLUME] knob	A
	14 P: Tone	24 [TONE] knob	A
	15 P: Damper Reso	25 DAMPER RESONANCE [ON/OFF] button	B
	16 P: Effect SW	26 Insertion effect [ON/OFF] button	B
	17 P: Effect Depth	28 [DEPTH] knob	A
	18 E: Select	18 Voice category selector	N
		19 Voice select switch	N
	19 E: Volume	23 [VOLUME] knob	A
	20 E: Tone	24 [TONE] knob	A
	21 E: Drive SW	26 Insertion effect [ON/OFF] button	B
	22 E: Drive Depth	29 [DRIVE] knob	A
	23 E: Effect 1 SW	26 Insertion effect [ON/OFF] button	B
	24 E: Effect 1 Depth	31 [DEPTH] knob	A
	25 E: Effect 1 Rate	32 [RATE] knob	A
	26 E: Effect 2 SW	26 Insertion effect [ON/OFF] button	B
	27 E: Effect 2 Depth	34 [DEPTH] knob	A
	28 E: Effect 2 Speed	35 [SPEED] knob	A
	29 S: Select	18 Voice category selector	O
		19 Voice select switch	O
	30 S: Volume	23 [VOLUME] knob	A
	31 S: Tone	24 [TONE] knob	A
	32 (Bank LSB)		
	34 (Data Entry LSB)		
	64 Sustain	*	
	65 (Portamento)		
	66 Sostenuto	*	
	67 Soft		
	68 S: Effect SW	26 Insertion effect [ON/OFF] button	B
	71 (Resonance)		
	72 S: Release	37 [RELEASE] knob	A
	73 S: Attack	38 [ATTACK] knob	A
	74 (Cutoff)		
	75 S: Effect Depth	39 [DEPTH] knob	A
	76 S: Effect Speed	40 [SPEED] knob	A
	77 P: Delay Depth	44 [DEPTH] knob	A
	78 E: Delay Depth	44 [DEPTH] knob	A
	79 S: Delay Depth	44 [DEPTH] knob	A
	80 Delay Time	46 [TIME] knob	A
	81 P: Reverb Depth	48 [DEPTH] knob	A
	82 E: Reverb Depth	48 [DEPTH] knob	A
	83 S: Reverb Depth	48 [DEPTH] knob	A
	84 (Portamento Ctrl)		
	85 Reverb Time	49 [TIME] knob	A
	86 Master EQ SW	50 MASTER EQUALIZER [ON/OFF] button	B
	87 Master EQ High	51 [HIGH] knob	C
	88 Master EQ Mid	52 [MID] knob	C
	89 Master EQ Freq	53 [FREQUENCY] knob	D
	90 Master EQ Low	54 [LOW] knob	C
	91 All Reverb Depth	48 [DEPTH] knob	A
	92 Delay Feedback	45 [FEEDBACK] knob	A
	93 All Delay Depth	44 [DEPTH] knob	A
	94 (Effect 4 Depth)		
	95 (Effect 5 Depth)		
	96 (Data Increment)		
	97 (Data Decrement)		
	98 (NRPN LSB)		
	99 (NRPN MSB)		
	100 (RPN LSB)		

	CC No. (LCD indication)	Panel controls	Table*
PEDAL	101 (RPN MSB)		
	102 P: SW	17 Voice section [ON/OFF] switch	B
	103 P: Split	21 SPLIT [L R] button	E
	104 P: Octave	22 OCTAVE [-2 -1]/[+1 +2] buttons	F
	105 P: Effect Type	27 Insertion effect switch button	G
	106 E: SW	17 Voice section [ON/OFF] switch	B
	107 E: Split	21 SPLIT [L R] button	E
	108 E: Octave	22 OCTAVE [-2 -1]/[+1 +2] buttons	F
	109 E: Effect 1 Type	30 Insertion effect switch button	H
	110 E: Effect 2 Type	32 [RATE] knob	I
	111 S: SW	17 Voice section [ON/OFF] switch	B
	112 S: Split	21 SPLIT [L R] button	E
	113 S: Octave	22 OCTAVE [-2 -1]/[+1 +2] buttons	F
	114 S: Effect Type	30 Insertion effect switch button	J
	115 Delay SW	42 DELAY [ON/OFF] switch	B
	116 Delay Effect Type	45 [Analog/Digital] switch button	K
	117 Reverb SW	47 REVERB [ON/OFF] switch	B
	118 Depth Knob Select	41 Effect level display switch button	L
---	Live Set Sound +	*	
---	Live Set Sound -	*	

Correspondence Table

A

Parameter	Controller	
	Transmitted	Recognized
0-127	0-127	0-127

B

Parameter	Controller	
	Transmitted	Recognized
Off	0	0-63
On	1	127

C

Parameter	Controller	
	Transmitted	Recognized
-12dB	52	0-5
-11dB	53	6-10
-10dB	54	11-15
-9dB	55	16-20
-8dB	56	21-25
-7dB	57	26-30
-6dB	58	31-35
-5dB	59	36-40
-4dB	60	41-46
-3dB	61	47-51
-2dB	62	52-56
-1dB	63	57-61
0dB	64	62-66
1dB	65	67-71
2dB	66	72-76
3dB	67	77-81
4dB	68	82-87
5dB	69	88-92
6dB	70	93-97
7dB	71	98-102
8dB	72	103-107
9dB	73	108-112
10dB	74	113-117
11dB	75	118-122
12dB	76	123-127

D

Parameter		Controller	
		Transmitted	Recognized
100Hz	14	0-3	0-3
110Hz	15	4-6	4-6
125Hz	16	7-9	7-9
140Hz	17	10-12	10-12
160Hz	18	13-15	13-15
180Hz	19	16-18	16-18
200Hz	20	19-21	19-21
225Hz	21	22-24	22-24
250Hz	22	25-28	25-28
280Hz	23	29-31	29-31
315Hz	24	32-34	32-34
355Hz	25	35-37	35-37
400Hz	26	38-40	38-40
450Hz	27	41-43	41-43
500Hz	28	44-46	44-46
560Hz	29	47-49	47-49
630Hz	30	50-53	50-53
700Hz	31	54-56	54-56
800Hz	32	57-59	57-59
900Hz	33	60-62	60-62
1.0kHz	34	63-65	63-65
1.1kHz	35	66-68	66-68
1.2kHz	36	69-71	69-71
1.4kHz	37	72-74	72-74
1.6kHz	38	75-78	75-78
1.8kHz	39	79-81	79-81
2.0kHz	40	82-84	82-84
2.2kHz	41	85-87	85-87
2.5kHz	42	88-90	88-90
2.8kHz	43	91-93	91-93
3.2kHz	44	94-96	94-96
3.6kHz	45	97-99	97-99
4.0kHz	46	100-102	100-102
4.5kHz	47	103-106	103-106
5.0kHz	48	107-109	107-109
5.6kHz	49	110-112	110-112
6.3kHz	50	113-115	113-115
7.0kHz	51	116-118	116-118
8.0kHz	52	119-121	119-121
9.0kHz	53	122-124	122-124
10kHz	54	125-127	125-127

E

Parameter		Controller	
		Transmitted	Recognized
L&R	0	0	0-42
L	1	63	43-85
R	2	127	86-127

F

Parameter	Controller	
	Transmitted	Recognized
-2	62	0-25
-1	63	26-51
0	64	52-76
+1	65	77-102
+2	66	103-127

G

Parameter	Controller	
	Transmitted	Recognized
Comp	0	0-31
Dist/OD	1	32-63
Drive	2	64-95
Chorus	3	96-127

DATA LIST

H

Parameter		Controller	
		Transmitted	Recognized
A.Pan	0	0	0-21
Trem	1	25	22-42
R.Mod	2	50	43-63
T.Wah	3	76	64-85
P.Wah	4	101	86-106
Comp	5	127	107-127

I

Parameter		Controller	
		Transmitted	Recognized
Cho1	0	0	0-21
Cho2	1	25	22-42
Fla	2	50	43-63
Pha1	3	76	64-85
Pha2	4	101	86-106
Pha3	5	127	107-127

J

Parameter		Controller	
		Transmitted	Recognized
Cho/Fla	0	0	0-31
Rotary	1	42	32-63
Trem	2	84	64-95
Dist/OD	3	127	96-127

K

Parameter		Controller	
		Transmitted	Recognized
Analog	0	0	0-63
Digital	1	127	64-127

L

Parameter		Controller	
		Transmitted	Recognized
All	0	0	0-31
Piano	1	42	32-63
E.Piano	2	84	64-95
Sub	3	127	96-127

M

Parameter		Controller	
		Transmitted	Recognized
Grand Piano	1	0	1
	2	1	2
	3	2	3
	4	3	4
Upright Piano	1	4	5
	2	5	6
CP	1	6	7
	2	7	8
Special Piano	1	8	9
	2	9	10

N

Parameter		Controller	
		Transmitted	Recognized
Rd	1	10	11
	2	11	12
	3	12	13
Wr	1	13	14
	2	14	15
Clv	1	15	16
	2	16	17
	3	17	18
DX	1	18	19
	2	19	20
	3	20	21
	4	21	22
	5	22	23
	6	23	24

O

Parameter		Controller		
		Transmitted	Recognized	
Pad/Strings	1	24	25	
	2	25	26	
	3	26	27	
	4	27	28	
	5	28	29	
	6	29	30	
	7	30	31	
	8	31	32	
	Organ	1	32	33
		2	33	34
3		34	35	
4		35	36	
5		36	37	
6		37	38	
7		38	39	
8		39	40	
9		40	41	
10		41	42	
Chromatic Perc	1	42	43	
	2	43	44	
	3	44	45	
	4	45	46	
	5	46	47	
	6	47	48	
	7	48	49	
	Others	1	49	50
2		50	51	
3		51	52	
4		52	53	
5		53	54	
6		54	55	
7		55	56	
8		56	57	

MIDI

Musical Instrument Digital Interface (MIDI) is a global standard designed to allow performance, Voice, and other data to be transferred between musical instruments. As such, reliable data communication is assured even between musical instruments and equipment from different manufacturers.

In addition to data generated by playing the keyboard or selecting a Live Set Sound, a wide range of other data types—such as tempo and instrument controls—can also be exchanged via MIDI. Using the powerful functionality provided by this technology, you can not only play other instruments using this instrument's keyboard and controllers, but you can also adjust the volume or the tone of each section and adjust effect settings. In fact, practically all of the parameters that can be set using the instrument's control panel can also be remotely controlled from another MIDI device.

MIDI Channels

MIDI data can be transmitted and received on one of sixteen MIDI channels. Therefore, performance data for up to sixteen different instrument parts can be simultaneously exchanged over a single MIDI cable. MIDI channels are very similar in nature to TV channels, in that each TV station transmits its broadcasts over a specific channel. Your TV, for example, receives many different programs at the same time from different broadcasters, and you select which program to watch by choosing the corresponding channel.

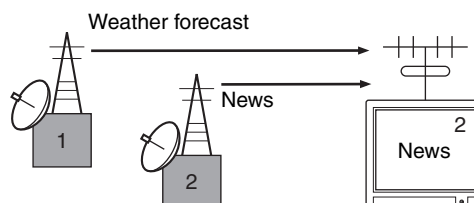

In much the same way, multiple transmitting devices in a MIDI system can each be set to send data on a separate channel (i.e., a MIDI transmit channel), which link with the system's receiving devices via MIDI cables. If a receiving device's MIDI channel (i.e., a MIDI receive channel) matches a MIDI Transmit channel, the receiving device will produce sound in response to the data sent by the corresponding transmitting device.

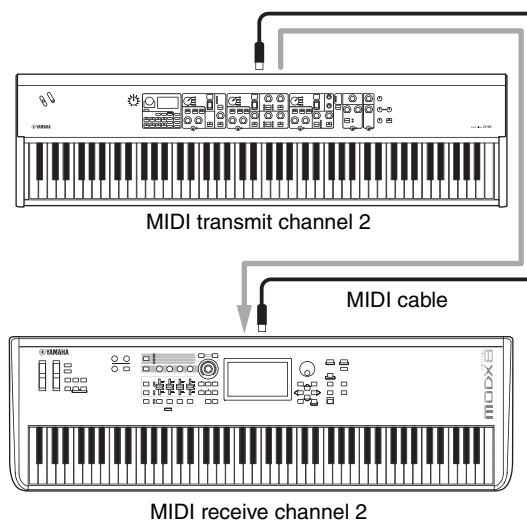

MIDI Data Format

(1) TRANSMIT FLOW

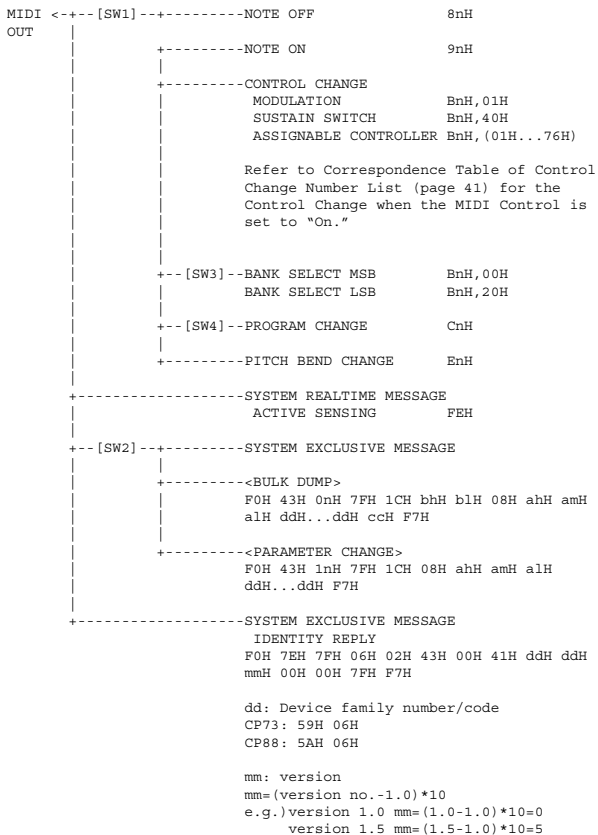

- [SW1] MIDI Transmit Channel
Complies with Zone Transmit Channel when the Part Zone Switch is set to on.
Complies with Part number in any other case.
- [SW2] SYSTEM MIDI Device Number
When set to all, transmitted via 1.
- [SW3] SYSTEM Bank Select Switch
- [SW4] SYSTEM Program Change Switch

(2) RECEIVE FLOW

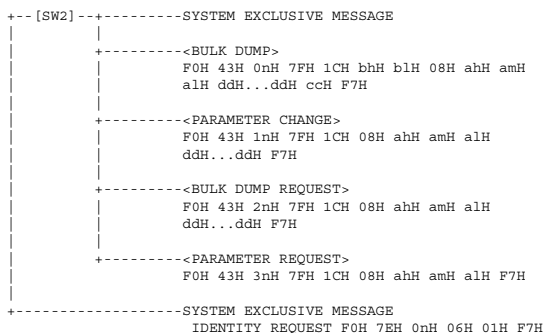
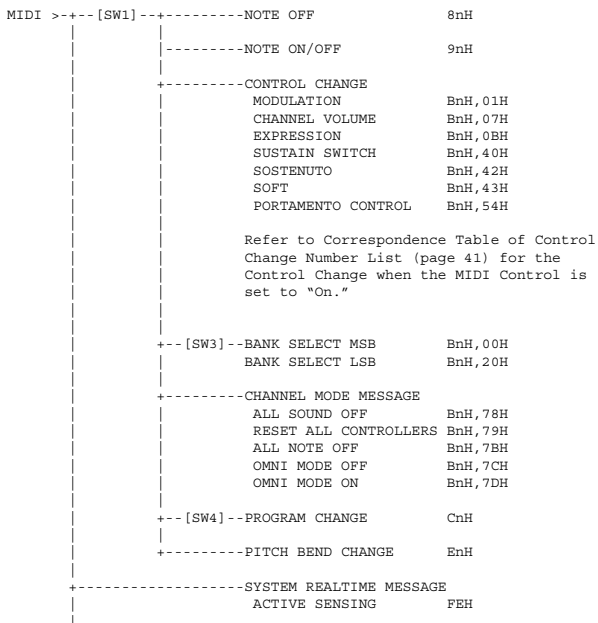

- [SW1] Complies with MIDI Receive Channel.
- [SW2] SYSTEM MIDI Device Number
- [SW3] SYSTEM Bank Select Switch
- [SW4] SYSTEM Program Change Switch

(3) TRANSMIT/RECEIVE DATA

(3-1) CHANNEL VOICE MESSAGES

(3-1-1) NOTE OFF

```

STATUS      1000nnnn (9nH)      n=0-15 CHANNEL NUMBER
NOTE No.    0kkkkkkk            k=0(C-2)-127(G8)
VELOCITY    0vvvvvvv            v=64 Transmit
  
```

(3-1-2) NOTE ON/OFF

```

STATUS      1000nnnn (8nH)      n=0-15 CHANNEL NUMBER
NOTE No.    0kkkkkkk            k=0(C-2)-127(G8)
VELOCITY NOTE ON 0vvvvvvv (v≠0)
NOTE OFF    0vvvvvvv (v=0)
  
```

(3-1-3) CONTROL CHANGE

```

STATUS      1011nnnn (BnH)      n=0-15 CHANNEL NUMBER
CONTROL NUMBER 0ccccccc
CONTROL VALUE  0vvvvvvv
  
```

*TRANSMITTED CONTROL NUMBER

c=0	BANK SELECT MSB	;v=0-127	*1
c=32	BANK SELECT LSB	;v=0-127	*1
c=1	MODULATION	;v=0-127	
c=64	SUSTAIN SWITCH	;v=0-127	*3
c=1...118	ASSIGNABLE CONTROLLER	;v=0-127	*2

*RECEIVED CONTROL NUMBER

c=0	BANK SELECT MSB	;v=0-127	*1
c=32	BANK SELECT LSB	;v=0-127	*1
c=1	MODULATION	;v=0-127	
c=7	CHANNEL VOLUME	;v=0-127	
c=11	EXPRESSION	;v=0-127	
c=64	SUSTAIN SWITCH	;v=0-127	
c=66	SOSTENUTO	;v=0-63:OFF, 64-127:ON	
c=67	SOFT	;v=0-127	
c=84	PORTAMENTO CONTROL	;v=0-127	

*1 Relation between BANK SELECT and PROGRAM is as follows:

CATEGORY	MSB	LSB	PROGRAM No.
Live Set Page 1	63	0	0..7
:	:	:	:
Live Set Page 20	63	19	0..7

*2 The default CONTROL NUMBERS of ASSIGNABLE CONTROLLER are as follows:

FOOT CONTROLLER 1	11
FOOT CONTROLLER 2	4
FOOT SWITCH Live Set Inc	

*3 When Sustain is set to something other than "FC3A (HalfOn)," operating the foot switch transmits only values of 0 (off) or 127 (on).

Bank Select will be actually executed when a Program Change message is received. Bank Select and Program Change numbers that are not supported by Yamaha will be ignored.

(3-1-4) PROGRAM CHANGE

```

STATUS      1100nnnn (CnH)      n=0-15 CHANNEL NUMBER
PROGRAM NUMBER 00000ppp          p=0-7
  
```

(3-1-5) PITCH BEND CHANGE

```

STATUS      1110nnnn (EnH)      n=0-15 CHANNEL NUMBER
LSB         0vvvvvvv            PITCH BEND CHANGE LSB
MSB         0vvvvvvv            PITCH BEND CHANGE MSB
Transmitted with a resolution of 7 bits.
  
```

(3-2) CHANNEL MODE MESSAGES

STATUS 1011nnnn (BnH) n=0-15 CHANNEL NUMBER
 CONTROL NUMBER 0ccccccc c=CONTROL NUMBER
 CONTROL VALUE 0vvvvvvv v=DATA VALUE

(3-2-1) ALL SOUND OFF (CONTROL NUMBER = 78H, DATA VALUE = 0)

All the sounds currently being played, including channel messages such as note-on and hold-on of a certain channel, are muted this message is received.

(3-2-2) RESET ALL CONTROLLERS (CONTROL NUMBER = 79H, DATA VALUE = 0)

Resets the values set for the following controllers.

PITCH BEND CHANGE 0 (center)
 MODULATION 0 (minimum)
 EXPRESSION 127 (maximum)
 PEDAL WAH 0 (minimum)
 SUSTAIN SWITCH 0 (off)
 SOSTENUTO SWITCH 0 (off)
 SOFT 0 (off)
 PORTAMENTO CONTROL Reserved note number

Doesn't reset the following data:
 PROGRAM CHANGE, BANK SELECT MSB/LSB, VOLUME

(3-2-3) ALL NOTE OFF (CONTROL NUMBER = 7BH, DATA VALUE = 0)

All the notes currently set to on in certain channel(s) are muted when receiving this message. However, if Sustain or Sostenuto is on, notes will continue sounding until these are turned off.

(3-2-4) OMNI MODE OFF (CONTROL NUMBER = 7CH, DATA VALUE = 0)

Performs the same function as when receiving ALL NOTES OFF.

(3-2-5) OMNI MODE ON (CONTROL NUMBER = 7DH, DATA VALUE = 0)

Performs the same function as when receiving ALL NOTES OFF.

(3-4) SYSTEM REAL TIME MESSAGES

(3-4-1) ACTIVE SENSING

STATUS 11111110 (FEH)

Transmitted every 200 msec.
 Once this code is received, the instrument starts sensing. When neither status messages nor data are received for more than approximately 350 ms, the MIDI receive buffer will be cleared, and the sounds currently being played are forcibly turned off.

(3-5) SYSTEM EXCLUSIVE MESSAGE

(3-5-1) UNIVERSAL NON REALTIME MESSAGE

(3-5-1-1) IDENTITY REQUEST (Receive only)

F0H 7EH 0nH 06H 01H F7H ("n" = Device No. However, this instrument receives under "omni.")

(3-5-1-2) IDENTITY REPLY (Transmit only)

F0H 7EH 7FH 06H 02H 43H 00H 41H ddH ddH mmH 00H 00H 7FH F7H

dd: Device family number/code
 CP73: 59H 06H
 CP88: 5AH 06H
 mm: version
 mm=(version no.-1.0)*10
 e.g.) version 1.0 mm=(1.0-1.0)*10=0
 version 1.5 mm=(1.5-1.0)*10=5

(3-5-2) UNIVERSAL REALTIME MESSAGE

(3-5-3) PARAMETER CHANGE

(3-5-3-1) NATIVE PARAMETER CHANGE, MODE CHANGE

11110000 F0 Exclusive status
 01000011 43 YAMAHA ID
 0001nnnn 1n Device Number
 01111111 7F Group ID High
 00011100 1C Group ID Low
 00000010 08 Model ID
 0aaaaaaaa aaaaaaa Address High
 0aaaaaaaa aaaaaaa Address Mid
 0aaaaaaaa aaaaaaa Address Low
 0ddddddd ddddddd Data
 |
 11110111 F7 End of Exclusive

For parameters with data size of 2 or more, the appropriate number of data bytes will be transmitted.
 See the following MIDI Data Table for Address.

(3-5-4) BULK DUMP

11110000 F0 Exclusive status
 01000011 43 YAMAHA ID
 0000nnnn 0n Device Number
 01111111 7F Group ID High
 00011100 1C Group ID Low
 0bbbbbbb bbbbbbb Byte Count
 0bbbbbbb bbbbbbb Byte Count
 00000010 08 Model ID
 0aaaaaaaa aaaaaaa Address High
 0aaaaaaaa aaaaaaa Address Mid
 0aaaaaaaa aaaaaaa Address Low
 0 0 Data
 | |
 0ccccccc ccccccc Checksum
 11110111 F7 End of Exclusive

See the following MIDI Data Table for Address and Byte Count.
 Checksum is the value that results in a value of 0 for the lower 7 bits

(3-5-5) DUMP REQUEST

when the Byte Count, Start Address, Data and Checksum itself are added.

11110000 F0 Exclusive status
 01000011 43 YAMAHA ID
 0010nnnn 2n Device Number
 01111111 7F Group ID High
 00011100 1C Group ID Low
 00000010 08 Model ID
 0aaaaaaaa aaaaaaa Address High
 0aaaaaaaa aaaaaaa Address Mid
 0aaaaaaaa aaaaaaa Address Low
 11110111 F7 End of Exclusive

See the following DUMP REQUEST Table for Address.

(3-5-6) PARAMETER REQUEST

11110000 F0 Exclusive status
 01000011 43 YAMAHA ID
 0011nnnn 3n Device Number
 01111111 7F Group ID High
 00011100 1C Group ID Low
 00000010 08 Model ID
 0aaaaaaaa aaaaaaa Address High
 0aaaaaaaa aaaaaaa Address Mid
 0aaaaaaaa aaaaaaa Address Low
 11110111 F7 End of Exclusive

See the following MIDI Data Table for Address.

(4) SYSTEM OVERVIEW (Keyboard and Tone Generator)

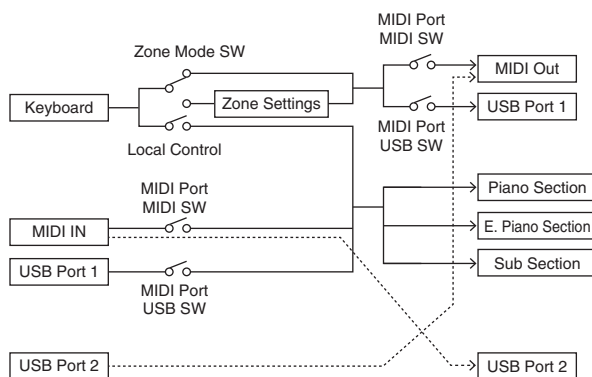

USB Port 2 is enabled when 'MIDI Port MIDI SW = OFF' and 'MIDI Port USB SW = ON'

ALL SOUND OFF clears all the sounds in the specific channel(s) played by both the keyboard and the data via MIDI.
 ALL NOTES OFF received via MIDI clears the sounds in the specific channel(s) played via MIDI.

MIDI Data Table

Bank Select

MSB	(HEX)	LSB	(HEX)	Program No.	Type	Memory	Description
63	3F	0	00	0-7	Live Set Sound	User	Live Set Page 1
		1	01	0-7		User	Live Set Page 2
		2	02	0-7		User	Live Set Page 3
		3	03	0-7		User	Live Set Page 4
		4	04	0-7		User	Live Set Page 5
		5	05	0-7		User	Live Set Page 6
		6	06	0-7		User	Live Set Page 7
		7	07	0-7		User	Live Set Page 8
		8	08	0-7		User	Live Set Page 9
		9	09	0-7		User	Live Set Page 10
		10	0A	0-7		User	Live Set Page 11
		11	0B	0-7		User	Live Set Page 12
		12	0C	0-7		User	Live Set Page 13
		13	0D	0-7		User	Live Set Page 14
		14	0E	0-7		User	Live Set Page 15
		15	0F	0-7		User	Live Set Page 16
		16	10	0-7		User	Live Set Page 17
		17	11	0-7		User	Live Set Page 18
		18	12	0-7		User	Live Set Page 19
19	13	0-7	User	Live Set Page 20			

Bulk Dump Block

"Top Address" indicates the top address of each block designated by the bulk dump operation. "Byte Count" indicates the data size contained in each block designated by the bulk dump operation. The block from the Bulk Header to the Bulk Footer of the Performance can be received regardless of their order; however, they cannot be received if an irrelevant Block is included. To execute 1 Multi/1 Voice bulk dump request, designate its corresponding Bulk Header address. For information about "mm" and "nn" shown in the following list, refer to the MIDI PARAMETER CHANGE TABLE (BULK CONTROL).

Group Number = 7F 1C, Model ID = 08

Parameter Block	Description	Byte Count		Top Address			
		Dec	Hex	High	Mid	Low	
System	System	48	30	20	00	00	
	Master EQ	20	14	20	40	00	
	Contents Unlock			20	70	00	
Live Set Sound	Bulk Header	0	00	0E	pp	0n	
	Common	Zone 1	16	10	4A	00	00
		:			:		
		Zone 4				03	
	Section	Piano Common	24	18	50	00	00
		E.Piano Common				01	
		Sub Common				02	
		Piano Specific	28	1C	50	10	00
		E.Piano Specific				11	
		Sub Specific				12	
	Bulk Footer			0F	pp	0n	

Parameter Base Address

Group Number = 7F 1C, Model ID = 08

Parameter Block	Top Address			Description
	High	Mid	Low	
	System	20	00	
BULK CONTROL	20	40	00	Master EQ
	0E	00	00	Header
	0F	00	00	Footer
STORE TO FLASH	0D	00	00	Store To Flash
Live Set Sound	46	00	00	Common
Zone	4A	zz	00	Zone (zz: 00 - 03)
Section	50	0p	00	Common
	50	1p	00	Specific

Message Type	Data
Parameter Change	F0, 43, 1n, gh, gl, id, ah, am, al, dt, ... F7
Parameter Request	F0, 43, 3n, gh, gl, id, ah, am, al F7
Bulk Dump	F0, 43, 0n, gh, gl, bh, bl, id, ah, am, al, dt, ..., cc, F7
Bulk Request	F0, 43, 2n, gh, gl, id, ah, am, al, F7

- n: Device Number
- gh: Group Number High
- gl: Group Number Low
- bh: Byte Count High
- bl: Byte Count Low
- id: Model ID
- ah: Parameter Address High
- am: Parameter Address Middle
- al: Parameter Address Low
- dt: Data
- cc: Data Checksum

MIDI PARAMETER CHANGE TABLE (BULK CONTROL)

Group Number = 7F 1C, Model ID = 08

Address			Size	Data Range (HEX)	Parameter Name	Description	Default (HEX)	Notes
High	Mid	Low						
0E	pp	0n	1	-	Bulk Header	Live Set Sound User (pp = 0 – 19, n = 0 – 7)	-	
	7F	00	1	-		Current Sound Buffer	-	
0F	pp	0n	1	-	Bulk Footer	Live Set Sound User (pp = 0 – 19, n = 0 – 7)	-	
	7F	00	1	-		Current Sound Buffer	-	

Address			Size	Data Range	Parameter Name	Description	Default (HEX)	Notes
High	Mid	Low						
		29	1	00 – 01	Live Set View Mode	Close, Keep	00	
		2A	1	00 – 13	Power On Page	1 – 20	00	
		2B	1	00 – 07	Power On Sound	1 – 8	00	
		2C	1	00 – 78	FS Control Number	Off, 1 – 118, 119 (Live Set Inc), 120 (Live Set Dec)	77	
		2D	1		reserved			
		2E	1	00 – 7F	USB Audio Volume	0 – 127	40	
		2F	1	00 – 02	Sustain Pedal Select	FC3 Half On, FC3 Half Off, FC4/5	00	

TOTAL SIZE = 48 30 (HEX)

SYSTEM

System Common

Group Number = 7F 1C, Model ID = 08

Address			Size	Data Range	Parameter Name	Description	Default (HEX)	Notes
High	Mid	Low						
20	00	00	1		reserved			
		01	1		reserved			
		02	4	00 – 00 00 – 07 00 – 0F 00 – 0F	Master Tune	-102.4 – +102.3 [cent] 1st bit3-0: bit15-12 2nd bit3-0: bit11-8 3rd bit3-0: bit7-4 4th bit3-0: bit3-0	00 04 00 00	
		06	1	3D – 43	Keyboard Octave Shift	-3 – 0 – +3	40	
		07	1	34 – 4C	Keyboard Transpose	-12 – +12 [semitones]	40	
		08	1	00 – 01	Controller Reset	Hold, Reset	01	
		09	1	00 – 01	Local Switch	Off, On	01	
		0A	1	00 – 0F, 7F	Tx Channel	1 – 16, Off	00	
		0B	1	00 – 10	Rx Channel	1 – 16, All	00	
		0C	1	00 – 03	MIDI Control	Off, Mode 1, Mode 2, Mode 3	00	
		0D	1		reserved			
		0E	1		reserved			
		0F	1		reserved			
		10	1	00 – 04	Keyboard Velocity Curve	Normal, Soft, Hard, Wide, Fixed	00	
		11	1	01 – 7F	Keyboard Fixed Velocity	1 – 127	40	
		12	1	00 – 01	Transmit/Receive Bank Select	Off, On	01	
		13	1	00 – 01	Transmit/Receive Program Change	Off, On	01	
		14	1		reserved			
		15	1	00 – 01	MIDI In/Out	USB Thru, In/Out	01	
		16	1	00 – 01	USB In/Out	Off, On	01	
		17	1		reserved			
		18	1		reserved			
		19	1	00 – 01	Display Lights Ins Effect	Off, On	01	
		1A	1	00 – 01	Display Lights Section	Off, On	01	
		1B	1	00 – 01	Display Lights LCD	Off, On	01	
		1C	1		reserved			
		1D	1		reserved			
		1E	1	00 – 01	Value Indication	Off, On	01	
		1F	1		reserved			
		20	1	00 – 01	SW Direction	Default, Reverse	00	
		21	1		reserved			
		22	1	00 – 3F	LCD Contrast	1 – 64	20	
		23	1	00 – 01	Panel Lock Live Set	Off, On	01	
		24	1	00 – 01	Panel Lock Section	Off, On	01	
		25	1	00 – 01	Panel Lock Effect	Off, On	01	
		26	1	00 – 01	Panel Lock Master EQ	Off, On	01	
		27	1		reserved			
		28	1	00 – 01	Section Hold	Disable, Enable	00	

System MEQ

Address			Size	Data Range	Parameter Name	Description	Default (HEX)	Notes
High	Mid	Low						
20	40	00	1	34 – 4C	EQ Gain1	-12dB – +12dB	40	
		01	1		reserved			
		02	1		reserved			
		03	1		reserved			
		04	1		reserved			
		05	1		reserved			
		06	1		reserved			
		07	1		reserved			
		08	1	34 – 4C	EQ Gain3	-12dB – +12dB	40	
		09	1	0E – 36	EQ Frequency3	100Hz – 10kHz	1C	
		0A	1		reserved			
		0B	1		reserved			
		0C	1		reserved			
		0D	1		reserved			
		0E	1		reserved			
		0F	1		reserved			
		10	1	34 – 4C	EQ Gain5	-12dB – +12dB	40	
		11	1		reserved			
		12	1		reserved			
		13	1		reserved			

TOTAL SIZE = 20 14 (HEX)

LIVE SET SOUND

Live Set Sound Common

Group Number = 7F 1C, Model ID = 08

Address			Size	Data Range	Parameter Name	Description	Default (HEX)	Notes
High	Mid	Low						
46	00	00	1	20 - 7F	Live Set Sound Name 1	32 - 127 (ASCII)	49	'l'
		01	1	20 - 7F	Live Set Sound Name 2	32 - 127 (ASCII)	6E	'n'
		02	1	20 - 7F	Live Set Sound Name 3	32 - 127 (ASCII)	69	'i'
		03	1	20 - 7F	Live Set Sound Name 4	32 - 127 (ASCII)	74	't'
		04	1	20 - 7F	Live Set Sound Name 5	32 - 127 (ASCII)	20	''
		05	1	20 - 7F	Live Set Sound Name 6	32 - 127 (ASCII)	53	'S'
		06	1	20 - 7F	Live Set Sound Name 7	32 - 127 (ASCII)	6F	'o'
		07	1	20 - 7F	Live Set Sound Name 8	32 - 127 (ASCII)	75	'u'
		08	1	20 - 7F	Live Set Sound Name 9	32 - 127 (ASCII)	6E	'n'
		09	1	20 - 7F	Live Set Sound Name 10	32 - 127 (ASCII)	64	'd'
		0A	1	20 - 7F	Live Set Sound Name 11	32 - 127 (ASCII)	20	
		0B	1	20 - 7F	Live Set Sound Name 12	32 - 127 (ASCII)	20	
		0C	1	20 - 7F	Live Set Sound Name 13	32 - 127 (ASCII)	20	
		0D	1	20 - 7F	Live Set Sound Name 14	32 - 127 (ASCII)	20	
		0E	1	20 - 7F	Live Set Sound Name 15	32 - 127 (ASCII)	20	
		0F	1		reserved			
		10	1		reserved			
		11	1	00 - 01	Zone Mode Switch	Off, On	00	
		12	1	00 - 01	Advanced Zone Mode Switch	Off, On	00	
		13	1		reserved			
		14	1		reserved			
		15	1	34 - 4C	TG Transpose	-12 - +12	40	
		16	1	01 - 7F	Split Point	C#-2 - G8	37	
		17	1		reserved			
		18	1		reserved			
		19	1	00 - 76	FC1 Assign	0 - 118	0B	
		1A	1	00 - 76	FC2 Assign	0 - 118	04	
		1B	1		reserved			
		1C	1		reserved			
		1D	1		reserved			
		1E	1		reserved			
		1F	1		reserved			
		20	1	00 - 03	Depth Knob Section Select	All, Piano, E.Piano, Sub	00	
		21	1		reserved			
		22	1		reserved			
		23	1		reserved			
		24	1	00 - 01	Delay Switch	Off, On	01	
		25	1	00 - 01	Delay Type	Analog, Digital	00	
		26	1	00 - 7F	Delay Feedback	0 - 127	40	
		27	1	00 - 7F	Delay Time	0 - 127	40	
		28	1	00 - 01	Reverb Switch	Off, On	01	
		29	1		reserved			
		2A	1		reserved			
		2B	1	00 - 7F	Reverb Time	0 - 127	40	
		2C	1		reserved			
		2D	1		reserved			
		2E	1		reserved			
		2F	1		reserved			

TOTAL SIZE = 48 30 (HEX)

ZONE

Group Number = 7F 1C, Model ID = 08

Address			Size	Data Range	Parameter Name	Description	Default (HEX)	Notes
High	Mid	Low						
4A	zz	00	1	00 - 01	Zone Switch	off, on	00 - 01	With the default settings, only the Zone 1 is set to "on."
		01	1	00 - 0F	Transmit Channel	Ch1 - 16	00 - 03	Default settings: Zone1(0) Zone2(1) Zone3(2) Zone4(3)
		02	1	3D - 43	Transpose (Octave)	-3 - +3	40	
		03	1	35 - 4B	Transpose (Semitone)	-11 - +11	40	
		04	1	00 - 7F	Note Limit Low	C-2 - G8	00	The upper limit will be determined with "Note Limit High."
		05	1	00 - 7F	Note Limit High	C-2 - G8	7F	The Lower limit will be determined with "Note Limit Low."
		06	1		reserved			
		07	1	00 - 7F	MIDI Volume	0 - 127	64	
		08	1	00 - 7F	MIDI Pan	L64 - C - R63	40	
		09	1	00 - 7F	MIDI Bank MSB	000 - 127	00	
		0A	1	00 - 7F	MIDI Bank LSB	000 - 127	00	
		0B	1	00 - 7F	MIDI Program Number	001 - 128	00	
		0C	1	00 - 1F	Transmit Bank Select Transmit Program Change Transmit Volume Transmit Pan Transmit Note	bit0: off, on Bank Select bit1: off, on Program Change bit2: off, on Volume bit3: off, on Pan bit4: off, on Note	1F	CC#11 (Expression) will not be transmitted when the Volume is set to "off."
		0D	1	00 - 3F	Transmit PB Transmit MW Transmit FC1 Transmit FC2 Transmit FS Transmit Sus	bit0: off, on PB bit1: off, on MW bit2: off, on FC1 bit3: off, on FC2 bit4: off, on FS bit5: off, on Sus	3F	
		0E	1		reserved			
		0F	1		reserved			

TOTAL SIZE = 16 10 (HEX)

zz = Zone Number
00 - 03 (HEX)

SECTION

Section Common

Group Number = 7F 1C, Model ID = 08

Address			Size	Data Range	Parameter Name	Description	Default (HEX)	Notes
High	Mid	Low						
50	0p	00	1	00 – 0B	Current Category		00	
		01	1	00 – 7F	Category 1 Voice Number		00	
		02	1	00 – 7F	Category 2 Voice Number		00	
		03	1	00 – 7F	Category 3 Voice Number		00	
		04	1	00 – 7F	Category 4 Voice Number		00	
		05	1	00 – 7F	Advanced Sound Mode Voice Number		00	
		06	1	00 – 01	Advanced Sound Mode Switch	Off, On	00	
		07	1	00 – 01	Section Switch	Off, On	01	
		08	1	00 – 02	Split Mode	L&R, L, R	00	
		09	1	3E – 42	Octave Shift	-2 – 0 – +2	40	
		0A	1	00 – 7F	Section Volume	0 – 127	7F (Piano), 40 (EP, Sub)	
		0B	1	00 – 7F	Tone	0 – 127	40	
		0C	1		reserved			
		0D	1	28 – 58	Pitch Bend Range	-24 – 0 – +24	42	
		0E	1		reserved			
		0F	1	00 – 7F	Pitch Modulation Depth	0 – 127	00 (Piano, EP), 0A (Sub)	
		10	1		reserved			
		11	1	00 – 01	Receive Expression	Off, On	01	
		12	1	00 – 01	Receive Sustain	Off, On	01	
		13	1	00 – 01	Receive Sostenuto	Off, On	01	
		14	1	00 – 01	Receive Soft	Off, On	01	
		15	1		reserved			
		16	1	00 – 7F	Delay Depth	0 – 127	00	
		17	1	00 – 7F	Reverb Depth	0 – 127	00	

TOTAL SIZE = 24 18 (HEX)

Section Specific

Address			Size	Data Range	Parameter Name	Description	Default (HEX)	Note
High	Mid	Low						
50	1p	00	1	00 – 01	Piano Damper Resonance Switch	Off, On	00	Only effective for the Piano Section
		01	1		reserved			
		02	1		reserved			
		03	1		reserved			
		04	1	00 – 01	Piano Effect Switch	Off, On	00	Only effective for the Piano Section
		05	1	00 – 03	Piano Effect Type	Comp, Dist/OD, Drive, Chorus	00	Only effective for the Piano Section
		06	1	00 – 7F	Piano Effect Depth	0 – 127	40	Only effective for the Piano Section
		07	1		reserved			
		08	1	00 – 01	E.Piano Effect 1 Switch	Off, On	00	Only effective for the E.Piano Section
		09	1	00 – 05	E.Piano Effect 1 Type	A.Pan, Trem, R.Mod, T.Wah, P.Wah, Comp	00	Only effective for the E.Piano Section
		0A	1	00 – 7F	E.Piano Effect 1 Depth	0 – 127	40	Only effective for the E.Piano Section
		0B	1	00 – 7F	E.Piano Effect 1 Rate	0 – 127	40	Only effective for the E.Piano Section
		0C	1	00 – 01	E.Piano Effect 2 Switch	Off, On	00	Only effective for the E.Piano Section
		0D	1	00 – 05	E.Piano Effect 2 Type	Cho1, Cho2, Fla, Pha1, Pha2, Pha3	00	Only effective for the E.Piano Section
		0E	1	00 – 7F	E.Piano Effect 2 Depth	0 – 127	40	Only effective for the E.Piano Section
		0F	1	00 – 7F	E.Piano Effect 2 Speed	0 – 127	40	Only effective for the E.Piano Section
		10	1	00 – 01	E.Piano Drive Switch	Off, On	00	Only effective for the E.Piano Section
		11	1	00 – 7F	E.Piano Drive	0 – 127	40	Only effective for the E.Piano Section
		12	1		reserved			
		13	1		reserved			
		14	1	00 – 01	Sub Effect Switch	Off, On	00	Only effective for the Sub Section
		15	1	00 – 03	Sub Effect Type	Cho/Fla, Rotary, Trem, Dist/OD	00	Only effective for the Sub Section
		16	1	00 – 7F	Sub Effect Depth	0 – 127	40	Only effective for the Sub Section
		17	1	00 – 7F	Sub Effect Speed	0 – 127	40	Only effective for the Sub Section
		18	1	00 – 7F	Sub Attack	0 – 127	40	Only effective for the Sub Section
		19	1	00 – 7F	Sub Release	0 – 127	40	Only effective for the Sub Section
		1A	1		reserved			
		1B	1		reserved			

TOTAL SIZE = 28 1C (HEX)

DATA LIST

YAMAHA [Stage Piano]
Model CP88/CP73 MIDI Implementation Chart

Date :29-NOV-2017
Version : 1.0

Function...	Transmitted	Recognized	Remarks	
Basic Channel	Default Changed	1 - 16 1 - 16	1 - 16 1 - 16	Memorized
Mode	Default Messages Altered	3 X *****	3 X X	Memorized
Note Number : True voice		0 - 127 *****	0 - 127 0 - 127	
Velocity	Note ON Note OFF	O 9nH,v=1-127 X 8nH,v=64	O 9nH,v=1-127 O 9nH,v=0 or 8nH	
After Touch	Key's Ch's	X X	X X	
Pitch Bend		O	O	
Control Change	0,32 1 7,11,67,84 64 66 12-31 68,72,73 75-83,85-93 102-118 1-118	O *2 O X O X O *1 O *1 O *1 O *1 O *1 O *3	O *2 O O O *2 O *2 O *1 O *1 O *1 O *1 X	Bank Select Sustain Sw Sostenuto
Prog Change : True #		O 0 - 127 *2	O 0 - 7 *2	
System Exclusive		O	O	
Common : Song Pos. : Song Sel. : Tune	X X X	X X X		
System : Clock Real Time : Commands	X X	X X		
Aux : All Sound Off : Reset All Cntrls : Local ON/OFF Mes- : All Notes OFF sages: Active Sense : Reset	X X X X O X	O (120) O (121) X O (123-125) O X		
Notes: *1 receive/transmit if MIDI control mode is on. *2 receive/transmit if switch is on. *3 transmit if assigned to foot controllers.				

Mode 1 : OMNI ON , POLY Mode 2 : OMNI ON , MONO O : Yes
Mode 3 : OMNI OFF, POLY Mode 4 : OMNI OFF, MONO X : No

Appendix

Display Messages

LCD indication	Description
Auto power off disabled.	This message appears when Auto Power Off is disabled.
Completed.	The specified load, save, format, or other Job has been completed.
Connecting to USB device...	Currently recognizing the USB flash drive connected to the USB [TO DEVICE] terminal.
Device number is off.	Bulk data cannot be transmitted/received because the device number is off.
Device number mismatch.	Bulk data cannot be received because the device numbers do not match.
File or folder already exists.	A file/folder having the same name as the one you are about to save already exists.
File or folder path is too long.	The file or folder you tried to access cannot be accessed because the maximum amount of characters indicating the path has been exceeded.
Illegal bulk data.	An error occurred while receiving a Bulk data or Bulk Request message.
Illegal file name.	The specified file name is invalid. Try entering a different name.
Illegal file.	The specified file is unusable by this instrument or cannot be loaded.
Incompatible USB device.	USB device which cannot be used with this instrument has been connected to the USB [TO DEVICE] terminal.
MIDI buffer full.	Failed to process the MIDI data because too much data was received at one time.
MIDI checksum error.	An error occurred when receiving bulk data.
No device.	Device is not connected.
No read/write authority to the file.	Indicates that you do not have the authority to read/write the file.
Now receiving MIDI bulk data...	Indicates this instrument is receiving MIDI bulk data.
Now transmitting MIDI bulk data...	Indicates this synthesizer is transmitting MIDI bulk data.
Please reboot to maintain internal memory.	Please reboot this instrument to restore the internal memory (NAND).
Push [PANEL LOCK] Button.	Push the [PANEL LOCK] button to disengage panel lock.
Unsupported USB device.	This message appears if the plugged-in USB flash drive is either unformatted or formatted in a way that this instrument does not support. Please format the USB device using this instrument.
USB connection terminated.	A break in the connection with the USB flash drive has occurred because of an abnormal electric current.
USB device is full.	The USB flash drive is full and no more data can be saved. Use a new USB flash drive, or make space by erasing unwanted data from the storage device.
USB device is write-protected.	This message appears when you have attempted to write to a protected USB flash drive.
USB device read/write error.	An error occurred while reading or writing to/from a USB flash drive.

Troubleshooting

No sound? Wrong sound? When a problem like this occurs, please check the following points before assuming that the product is faulty. Many problems can be solved by executing the Factory Reset operation (page 21). If the problem persists, consult your Yamaha dealer.

Issue	Suspected cause	Solution
The instrument turns off unexpectedly.	This is normal when the Auto Power Off function is enabled.	If necessary, you can deactivate the Auto Power Off function to prevent it turning off the instrument again (page 21).
No sound is produced.	Related external equipment (e.g., amplifier, speaker, headphones) is not properly connected to this instrument via audio cables.	Since this instrument has no built-in speakers, you will need an external audio system or a set of stereo headphones to properly monitor it (page 20).
	Power to this instrument or the connected external audio equipment are not turned on.	Check the power to this instrument and the connected external audio equipment are turned on.
	The volume of this instrument and the connected external audio equipment are turned fully down.	Adjust the volume. Use the [MASTER VOLUME] knob to adjust the volume. If a foot controller has been connected to the FOOT CONTROLLER [1]/[2] jacks, try using it to increase the volume.
	All the Voice section [ON/OFF] switches are set to OFF.	Set the Voice section [ON/OFF] switch to ON.
	The volume of Voice sections are turned fully down.	Use the [VOLUME] knobs of each Voice section to adjust the volume.
	Local Control is set to "Off"	When the Local Control is set to "Off", the internal tone generator will not sound. Set the Local Control to "On" (page 30).
	MIDI volume or expression has been set to a very low level by an external MIDI controller.	Select other Live Set Sound. If a foot controller has been connected to the FOOT CONTROLLER [1]/[2] jacks, try using it to increase the volume.
A sound continues to play without end.	Effect sound such as delay continues.	Lower the feedback level or set the DELAY [ON/OFF] switch to OFF. If other Live Set Sound is selected during a sound continues to play, press again the Live Set Sound button currently selected.
Sounds are distorted.	Effect settings are not appropriate.	Sound will be distorted depending on the effect types and the settings. Change the effect types and the settings.
	Volume is set too high.	Adjust the volume.
	Volume of this instrument and the external audio equipment are set too high.	Adjust the volume of an external audio equipment, or use the INPUT [GAIN] knob of this instrument. You can also adjust the volume from the "USB Audio Volume."
Sound output is intermittent and stuttered.	The entire sound exceeded the maximum polyphony (128 notes).	Keep in mind not to exceed the maximum polyphony.
No effect is applied.	The depth is turned to the minimum level.	Use the [DEPTH] knob to adjust the effect depth.
Data communication between the computer and this instrument does not work properly.	The Port settings on the computer is not appropriate.	Check the port settings on the computer.

Issue	Suspected cause	Solution
MIDI bulk data transmission does not work properly.	Using wrong terminals (MIDI, USB).	Check the connection.
	Wrong MIDI device number.	Check the MIDI device number.
Cannot save data to the external USB flash drive.	The USB flash drive is write protected.	Unlock the write protect.
	The USB flash drive is not formatted properly.	Format again.
A pedal has no effect.	The pedal is not correctly connected.	Ensure that the pedal's cord is fully plugged in.
The Voice numbers not displayed.	The "Advanced Mode SW" is enabled (On).	Disable (Off) the "Advanced Mode SW" (page 35).
Nothing is displayed on the LCD, even the instrument's power is on.	"Display Lights" → "LCD SW" is set to "Off".	Set the "LCD SW" to "On" (page 31).
	"Display Lights" → "LCD Contrast" value is set too low.	Adjust the contrast from "LCD Contrast" (page 31).

Specifications

Item		Details	
		CP88	CP73
Keyboard		88-key NW-GH3 (Natural Wood Graded Hammer) keyboard: synthetic ebony and ivory keytops	73-key BHS (Balanced Hammer Standard) keyboard: matte black keytops
Tone Generation	Tone Generation Technology	AWM2	
	Polyphony (max.)	128	
Voices	Number of Live Set Sounds	160 (Preset Live Set Sounds: 80)	
	Number of Voices	57 (PIANO: 10 / E.PIANO: 14 / SUB: 33)	
	Effects	Insertion Effect: PIANO 2 systems (1: Damper Resonance 2: Compressor, Distortion, Drive, Chorus) E.PIANO 3 systems (1: Drive 2: Auto Pan, Tremolo, Ring Modulator, Touch Wah, Pedal Wah, Compressor 3: Chorus1, Chorus2, Flanger, Phaser1, Phaser2, Phaser3) SUB 1 system (Chorus/Flanger, Rotary Speaker, Tremolo, Distortion) Delay: 2 types (Analog, Digital) Reverb 3 band EQ (with sweepable Mid)	
Display	Type	Full Dot LCD (128 x 64 dots)	
Connectors		OUTPUT [L/MONO]/[R] (6.3 mm, standard phone jacks, UNBALANCED) OUTPUT [L]/[R] (XLR jacks, BALANCED) [PHONES] (6.3 mm, standard stereo phone jack) INPUT [L/MONO]/[R] (6.3 mm, standard phone jacks) FOOT CONTROLLER [1]/[2] FOOT SWITCH [SUSTAIN]/[ASSIGNABLE] MIDI [IN]/[OUT] USB [TO HOST]/[TO DEVICE] [AC IN]	
Size/Weight	Dimensions (W x D x H)	1298 mm x 364 mm x 141 mm (51-1/8" x 14-5/16" x 5-9/16")	1086 mm x 355 mm x 144 mm (42-3/4" x 14" x 5-11/16")
	Weight	18.6 kg (41 lb, 0 oz)	13.1 kg (28 lb, 14 oz)
Included Accessories		Owner's Manual (this book) x 1 Power cord x 1 Foot pedal (FC3A) x 1	

The contents of this manual apply to the latest specifications as of the printing date.

Since Yamaha makes continuous improvements to the product, this manual may not apply to the specifications of your particular product. To obtain the latest manual, access the Yamaha website then download the manual file.

Index

A

Auto Power Off21

C

Computer26

D

DAW (digital audio workstation)26

Delay section17

E

Effect16

Electric Piano section15

External MIDI keyboard25

F

Factory Reset21

File type23

I

iPad27

iPhone27

L

Live Set12

Live Set Sound12

Live Set View12

M

Master EQ17

MENU28

MIDI channel43

MIDI device25

MIDI port25

MIDI receive channel25

MIDI transmit channel25

P

Piano section14

R

Reverb section17

S

SETTINGS33

Split13

SSS (Seamless Sound Switching)12

Sub section16

Synthesizer25

T

Tone generator module25

U

USB Audio27

USB flash drive23

USB [TO DEVICE]24

USB [TO HOST]27

Y

Yamaha Steinberg USB Driver26

MEMO

MEMO



YAMAHA LIMITED 3-YEAR WARRANTY ON DIGITAL PIANOS (P, CP, YDP & DGX600 SERIES)

Thank you for selecting a YAMAHA product. YAMAHA products are designed and manufactured to provide a high level of defect-free performance. Yamaha Corporation of America ("YAMAHA") is proud of the experience and craftsmanship that goes into each and every YAMAHA product. YAMAHA sells its products through a network of reputable, specially authorized dealers and is pleased to offer you, the Original Owner, the following Limited Warranty, which applies only to products that have been (1) directly purchased from YAMAHA's authorized dealers in the fifty states of the USA and District of Columbia (the "Warranted Area") and (2) used exclusively in the Warranted Area. YAMAHA suggests that you read the Limited Warranty thoroughly, and invites you to contact your authorized YAMAHA dealer or YAMAHA Customer Service if you have any questions.

Coverage: YAMAHA will, at its option, repair or replace the product covered by this warranty if it becomes defective, malfunctions or otherwise fails to conform with this warranty under normal use and service during the term of this warranty, without charge for labor or materials. Repairs may be performed using new or refurbished parts that meet or exceed YAMAHA specifications for new parts. If YAMAHA elects to replace the product, the replacement may be a reconditioned unit. You will be responsible for any installation or removal charges and for any initial shipping charges if the product(s) must be shipped for warranty service. However, YAMAHA will pay the return shipping charges to any destination within the USA if the repairs are covered by the warranty. This warranty does not cover (a) damage, deterioration or malfunction resulting from accident, negligence, misuse, abuse, improper installation or operation or failure to follow instructions according to the Owner's Manual for this product; any shipment of the product (claims must be presented to the carrier); repair or attempted repair by anyone other than YAMAHA or an authorized YAMAHA Service Center; (b) any unit which has been altered or on which the serial number has been defaced, modified or removed; (c) normal wear and any periodic maintenance; (d) deterioration due to perspiration, corrosive atmosphere or other external causes such as extremes in temperature or humidity; (e) damages attributable to power line surge or related electrical abnormalities, lightning damage or acts of God; or (f) RFI/EMI (Interference/noise) caused by improper grounding or the improper use of either certified or uncertified equipment, if applicable. Any evidence of alteration, erasing or forgery of proof-of-purchase documents will cause this warranty to be void. This warranty covers only the Original Owner and is not transferable.

In Order to Obtain Warranty Service: Warranty service will only be provided for defective products within the Warranted Area. Contact your local authorized YAMAHA dealer who will advise you of the procedures to be followed. If this is not successful, contact YAMAHA at the address, telephone number or website shown below. YAMAHA may request that you send the defective product to a local authorized YAMAHA Servicer or authorize return of the defective product to YAMAHA for repair. If you are uncertain as to whether a dealer has been authorized by YAMAHA, please contact YAMAHA's Service Department at the number shown below, or check Yamaha's website at www.usa.yamaha.com. Product(s) shipped for service should be packed securely and must be accompanied by a detailed explanation of the problem(s) requiring service, together with the original or a machine reproduction of the bill of sale or other dated, proof-of-purchase document describing the product, as evidence of warranty coverage. Should any product submitted for warranty service be found ineligible therefore, an estimate of repair cost will be furnished and the repair will be accomplished only if requested by you and upon receipt of payment or acceptable arrangement for payment.

Limitation of Implied Warranties and Exclusion of Damages: ANY IMPLIED WARRANTIES, INCLUDING WARRANTIES OF MERCHANTABILITY AND FITNESS FOR A PARTICULAR PURPOSE SHALL BE LIMITED IN DURATION TO THE APPLICABLE PERIOD OF TIME SET FORTH ABOVE. YAMAHA SHALL NOT BE RESPONSIBLE FOR INCIDENTAL OR CONSEQUENTIAL DAMAGES OR FOR DAMAGES BASED UPON INCONVENIENCE, LOSS OF USE, DAMAGE TO ANY OTHER EQUIPMENT OR OTHER ITEMS AT THE SITE OF USE OR INTERRUPTION OF PERFORMANCES OR ANY CONSEQUENCES THEREOF. YAMAHA'S LIABILITY FOR ANY DEFECTIVE PRODUCT IS LIMITED TO REPAIR OR REPLACEMENT OF THE PRODUCT, AT YAMAHA'S OPTION. SOME STATES DO NOT ALLOW LIMITATIONS ON HOW LONG AN IMPLIED WARRANTY LASTS OR THE EXCLUSION OR LIMITATION OF INCIDENTAL OR CONSEQUENTIAL DAMAGES, SO THE ABOVE LIMITATION OR EXCLUSION MAY NOT APPLY TO YOU. This Warranty gives you specific legal rights, and you may also have other rights which vary from state to state. This is the only express warranty applicable to the Product specified herein; Yamaha neither assumes nor authorizes anyone to assume for it any other express warranty.

If you have any questions about service received or if you need assistance in locating an authorized YAMAHA Servicer, please contact:



CUSTOMER SERVICE
Yamaha Corporation of America
6600 Orangethorpe Avenue, Buena Park, California 90620-1373
Telephone: 800-854-1569
www.usa.yamaha.com

Do not return any product to the above address without a written Return Authorization issued by YAMAHA.

© 2017 Yamaha Corporation of America.

For details of products, please contact your nearest Yamaha representative or the authorized distributor listed below.

Pour plus de détails sur les produits, veuillez-vous adresser à Yamaha ou au distributeur le plus proche de vous figurant dans la liste suivante.

Die Einzelheiten zu Produkten sind bei Ihrer unten aufgeführten Niederlassung und bei Yamaha Vertragshändlern in den jeweiligen Bestimmungsländern erhältlich.

Para detalles sobre productos, contacte su tienda Yamaha más cercana o el distribuidor autorizado que se lista debajo.

NORTH AMERICA

CANADA

Yamaha Canada Music Ltd.
135 Milner Avenue, Toronto, Ontario M1S 3R1,
Canada
Tel: +1-416-298-1311

U.S.A.

Yamaha Corporation of America
6600 Orangethorpe Avenue, Buena Park, CA 90620,
U.S.A.
Tel: +1-714-522-9011

CENTRAL & SOUTH AMERICA

MEXICO

Yamaha de México, S.A. de C.V.
Av. Insurgentes Sur 1647 Piso 9, Col. San José
Insurgentes, Delegación Benito Juárez, México,
D.F., C.P. 03900, México
Tel: +52-55-5804-0600

BRAZIL

Yamaha Musical do Brasil Ltda.
Rua Fidêncio Ramos, 302 – Cj 52 e 54 – Torre B –
Vila Olímpia – CEP 04551-010 – São Paulo/SP,
Brazil
Tel: +55-11-3704-1377

ARGENTINA

**Yamaha Music Latin America, S.A.,
Sucursal Argentina**
Olga Cossettini 1553, Piso 4 Norte,
Madero Este-C1107CEK,
Buenos Aires, Argentina
Tel: +54-11-4119-7000

PANAMA AND OTHER LATIN AMERICAN COUNTRIES/ CARIBBEAN COUNTRIES

Yamaha Music Latin America, S.A.
Edif. Torre Banco General, F7, Urb. Marbella,
Calle 47 y Aquilino de la Guardia, Panama,
P.O.Box 0823-05863, Panama, Rep.de Panama
Tel: +507-269-5311

EUROPE

THE UNITED KINGDOM/IRELAND

Yamaha Music Europe GmbH (UK)
Sherbourne Drive, Tilbrook, Milton Keynes,
MK7 8BL, U.K.
Tel: +44-1908-366700

GERMANY

Yamaha Music Europe GmbH
Siemensstrasse 22-34, 25462 Rellingen, Germany
Tel: +49-4101-303-0

SWITZERLAND/LIECHTENSTEIN

**Yamaha Music Europe GmbH, Branch
Switzerland in Thalwil**
Seestrasse 18a, 8800 Thalwil, Switzerland
Tel: +41-44-3878080

AUSTRIA/CROATIA/CZECH REPUBLIC/ HUNGARY/ROMANIA/SLOVAKIA/ SLOVENIA

Yamaha Music Europe GmbH, Branch Austria
Schleiergasse 20, 1100 Wien, Austria
Tel: +43-1-60203900

POLAND

**Yamaha Music Europe GmbH
Sp.z o.o. Oddział w Polsce**
ul. Wielicka 52, 02-657 Warszawa, Poland
Tel: +48-22-880-08-88

BULGARIA

Dinacord Bulgaria LTD.
Bul. Iskarsko Schose 7 Targowski Zentar Evropa
1528 Sofia, Bulgaria
Tel: +359-2-978-20-25

MALTA

Olimpus Music Ltd.
Valletta Road, Mosta MST9010, Malta
Tel: +356-2133-2093

NETHERLANDS/BELGIUM/ LUXEMBOURG

Yamaha Music Europe, Branch Benelux
Clarissenhof 5b, 4133 AB Vianen, The Netherlands
Tel: +31-347-358040

FRANCE

Yamaha Music Europe
7 rue Ambroise Croizat, Zone d'activités de Pariest,
77183 Croissy-Beaubourg, France
Tel: +33-1-6461-4000

ITALY

Yamaha Music Europe GmbH, Branch Italy
Via Tinelli N.67/69 20855 Gerno di Lesmo (MB),
Italy
Tel: +39-039-9065-1

SPAIN/PORTUGAL

**Yamaha Music Europe GmbH Ibérica, Sucursal
en España**
Ctra. de la Coruña km. 17,200, 28231
Las Rozas de Madrid, Spain
Tel: +34-91-639-88-88

GREECE

Philippou Nakas S.A. The Music House
19th klm. Leof. Lavriou 190 02 Peania – Attiki,
Greece
Tel: +30-210-6686260

SWEDEN

**Yamaha Music Europe GmbH Germany filial
Scandinavia**
JA Wettergrensgata 1, 400 43 Göteborg, Sweden
Tel: +46-31-89-34-00

DENMARK

**Yamaha Music Denmark,
Filiál of Yamaha Music Europe GmbH, Tyskland**
Generatorvej 8C, ST. TH., 2860 Søborg, Denmark
Tel: +45-44-92-49-00

FINLAND

F-Musiikki Oy
Antaksentie 4
FI-01510 Vantaa, Finland
Tel: +358 (0)96185111

NORWAY

**Yamaha Music Europe GmbH Germany -
Norwegian Branch**
Grini Næringspark 1, 1332 Østerås, Norway
Tel: +47-6716-7800

ICELAND

Hljóðfaerahúsid Ehf.
Sidumula 20
IS-108 Reykjavik, Iceland
Tel: +354-525-5050

CYPRUS

Nakas Music Cyprus Ltd.
Nikis Ave 2k
1086 Nicosia
Tel: + 357-22-511080
Major Music Center
21 Ali Riza Ave. Ortakoy
P.O.Box 475 Lefkoşa, Cyprus
Tel: (392) 227 9213

RUSSIA

Yamaha Music (Russia) LLC.
Room 37, entrance 7, bld. 7, Kievskaya street,
Moscow, 121059, Russia
Tel: +7-495-626-5005

OTHER EUROPEAN COUNTRIES

Yamaha Music Europe GmbH
Siemensstrasse 22-34, 25462 Rellingen, Germany
Tel: +49-4101-303-0

AFRICA

Yamaha Music Gulf FZE
JAFZA-16, Office 512, P.O.Box 17328,
Jebel Ali FZE, Dubai, UAE
Tel: +971-4-801-1500

MIDDLE EAST

TURKEY

**Yamaha Music Europe GmbH
Merkezi Almanya Türkiye İstanbul Şubesi**
Maslak Meydanı Sokak, Spring Giz Plaza Bagimsiz
Böl. No:3, Sarıyer İstanbul, Turkey
Tel: +90-212-999-8010

ISRAEL

RBX International Co., Ltd.
P.O Box 10245, Petach-Tikva, 49002
Tel: (972) 3-925-6900

OTHER COUNTRIES

Yamaha Music Gulf FZE
JAFZA-16, Office 512, P.O.Box 17328,
Jebel Ali FZE, Dubai, UAE
Tel: +971-4-801-1500

ASIA

THE PEOPLE'S REPUBLIC OF CHINA

Yamaha Music & Electronics (China) Co., Ltd.
2F, Yunhedasha, 1818 Xinzha-lu, Jingan-qu,
Shanghai, China
Tel: +86-400-051-7700

HONG KONG

Tom Lee Music Co., Ltd.
11/F., Silvercord Tower 1, 30 Canton Road,
Tsimshatsui, Kowloon, Hong Kong
Tel: +852-2737-7688

INDIA

Yamaha Music India Private Limited
P-401, JMD Megapolis, Sector-48, Sohna Road,
Gurgaon-122018, Haryana, India
Tel: +91-124-485-3300

INDONESIA

PT. Yamaha Musik Indonesia (Distributor)
Yamaha Music Center Bldg. Jalan Jend. Gatot
Subroto Kav. 4, Jakarta 12930, Indonesia
Tel: +62-21-520-2577

KOREA

Yamaha Music Korea Ltd.
11F, Prudential Tower, 298, Gangnam-daero,
Gangnam-gu, Seoul, 06253, Korea
Tel: +82-2-3467-3300

MALAYSIA

Yamaha Music (Malaysia) Sdn. Bhd.
No.8, Jalan Perbandaran, Kelana Jaya, 47301
Petaling Jaya, Selangor, Malaysia
Tel: +60-3-78030900

SINGAPORE

Yamaha Music (Asia) Private Limited
Block 202 Hougang Street 21, #02-00,
Singapore 530202, Singapore
Tel: +65-6740-9200

TAIWAN

Yamaha Music & Electronics Taiwan Co., Ltd.
2F., No.1, Yuandong Rd., Banqiao Dist.,
New Taipei City 22063, Taiwan (R.O.C.)
Tel: +886-2-7741-8888

THAILAND

Siam Music Yamaha Co., Ltd.
3, 4, 15, 16th Fl., Siam Motors Building,
891/1 Rama 1 Road, Wangmai,
Pathumwan, Bangkok 10330, Thailand
Tel: +66-2215-2622

VIETNAM

Yamaha Music Vietnam Company Limited
15th Floor, Nam A Bank Tower, 201-203 Cach
Mang Thang Tam St., Ward 4, Dist.3,
Ho Chi Minh City, Vietnam
Tel: +84-28-3818-1122

OTHER ASIAN COUNTRIES

[https://asia-latinamerica-mea.yamaha.com/
index.html](https://asia-latinamerica-mea.yamaha.com/index.html)

OCEANIA

AUSTRALIA

Yamaha Music Australia Pty. Ltd.
Level 1, 80 Market Street, South Melbourne,
VIC 3205 Australia
Tel: +61-3-9693-5111

NEW ZEALAND

Music Works LTD
P.O.BOX 6246 Wellesley, Auckland 4680,
New Zealand
Tel: +64-9-634-0099

COUNTRIES AND TRUST TERRITORIES IN PACIFIC OCEAN

[https://asia-latinamerica-mea.yamaha.com/
index.html](https://asia-latinamerica-mea.yamaha.com/index.html)

